

# NEXUS

NEW TIMES MAGAZINE

Volume 5, Number 5 AUGUST - SEPTEMBER 1998

PO Box 30, Mapleton Qld 4560, Australia

## CONTENTS

LETTERS TO THE EDITOR.....4	SUPPRESSED EVIDENCE FOR ANCIENT MAN.....55
GLOBAL NEWS.....6	<i>By Dr Virginia Steen-McIntyre. Proof that humans hunted mammoth in Mexico 250,000 years ago has been buried by establishment scientists with their ossified theories on the peopling of the Americas.</i>
<i>A round-up of the news you may have missed.</i>	THE TWILIGHT ZONE.....61
THE MILLENNIUM BUG: IS THERE A CURE?.....13	<i>Strange tales from around/within/beyond the world. This issue, we report on an alleged time traveller who has provided US talkshow host Art Bell with some intriguing headlines from the near future.</i>
<i>By Peter Montague, and also with Alan Simpson. Governments, utilities and businesses are not only grossly underprepared for the Y2K problem, they have no crisis plan for the effects of imminent meteorite showers and the 1999 "solar max" event.</i>	UFOs & EBes: MORE INSIDER EVIDENCE.....67
SPOOKS, WHISTLEBLOWERS & FALL GUYS.....21	<i>By Linda Moulton Howe. A former US Army Signal Corps and CIA officer who toured Area 51 in 1958 is the latest ex-insider to divulge details on what the government is hiding about UFOs and alien races.</i>
<i>By Uri Dowbenko. The first of a two-part interview with the whistleblowers' whistleblower, Rodney Stich, on US state-sponsored terrorism and drug-running, institutional and corporate corruption, and the informants who want the truth to come out.</i>	REVIEWS—Books.....75
THE HEALTH DANGERS OF DAIRY PRODUCTS.....27	<i>"Damanhur: The Real Dream" by Jeff Merrifield</i>
<i>With Robert Cohen. Powerful interests insist that cow's milk is good for us, despite contrary medical evidence and, in the US, the addition of antibiotics and untested, engineered hormones.</i>	<i>"Glimpses of Other Realities" by Linda Moulton Howe</i>
SHAKEN BABIES: THE VACCINATION LINK.....35	<i>"The Perils of Progress" by John Ashton and Ron Laura</i>
<i>By Dr Viera Scheibner. Parents and care-givers are increasingly being accused of causing shaking injuries to infants, when evidence suggests such injuries can also be the result of vaccine damage.</i>	<i>"Atlantis in America" by Ivar Zapp and George Erikson</i>
THE BECK ZAPPER: NEW HOPE AGAINST AIDS.....41	<i>"Letter to Earth" by Elia Wise</i>
<i>By Dr Robert Beck. An electromedical device that's cheap and easy to build is reported to have a high success rate in neutralising HIV and eliminating a host of disease-causing microbes.</i>	<i>"Northumberland Dreaming" by Mary Rhees Merker</i>
NEW SCIENCE NEWS.....49	<i>"Flying Saucers Over Los Angeles" by Dewayne B. Johnson</i>
<i>Interesting news and views from the underground science network. Here, Barry Hilton describes Joe X's revolutionary fuel cells that can power a car by seemingly extracting energy from the ether.</i>	<i>"Remarkable Healings" by Shakuntala Modi, MD</i>
	<i>"Faces of the Visitors" by Kevin Randle and Russ Estes</i>
	<i>"Technology's Curse: Diet for the Atomic Age" by Sara Shannon</i>
	<i>"Thoth: Architect of the Universe" by R. Ellis</i>
	<i>"The Hidden Maya" by Martin Brennan</i>
	<i>"Breaking the Sound Barrier of Human Energy..." by John O'Neill</i>
	<i>"Pre-Tasman Explorers" by Ross Wiseman</i>
	REVIEWS—Videos.....82
	<i>"Holes in Heaven? HAARP &amp; Advances in Tesla Technology"</i>
	<i>"Remembering the End of the World"</i>
	<i>"The Money Masters"</i>
	REVIEWS—Product.....82
	<i>"Air Supply Personal Air Purifier"</i>
	REVIEWS—Audio.....83
	<i>"Bothy Culture" by Martyn Bennett</i>
	<i>"Dance in the Fire" by Paul Cheneour and Dilly Meah</i>
	<i>"Sura" by Chloë Goodchild</i>
	<i>"Benediction Moon" by Pia</i>
	<i>"Cosmic Tree" by Yulara</i>
	NEXUS BOOKS, SUBS, ADS & VIDEOS.....97

# NEXUS MAGAZINE

Volume 5, Number 5

AUGUST-SEPTEMBER 1998

PUBLISHED BY

NEXUS Magazine Pty Ltd, ACN #003 611 434

EDITOR

Duncan M. Roads

CO-EDITOR

Catherine Simons

ASSISTANT EDITOR/SUB-EDITOR

Ruth Parnell

EDITORS' ASSISTANT

Richard Giles

OFFICE ADMINISTRATOR

Janine Carmichael

CONTRIBUTORS THIS ISSUE

Peter Montague; Alan Simpson; Uri Dowbenko;

Robert Cohen; Viera Scheibner, PhD;

Robert C. Beck, DSc; Barry Hilton; Virginia

Steen-McIntyre, PhD; Linda Moulton Howe

LAYOUT & DESIGN

Duncan M. Roads

CARTOONS

Phil Somerville

COVER GRAPHIC

John Cook, [jscook@ozemail.com.au](mailto:jscook@ozemail.com.au)

PRINTING

Warwick Daily News, Queensland, Australia

AUSTRALIAN DISTRIBUTION

Newsagents Direct Distribution

HEAD OFFICE - All Correspondence

PO Box 30, Mapleton, Qld 4560, Australia.

Ph: (07) 5442 9280; Fax: (07) 5442 9381

E-mail address: [nexus@peg.apc.org](mailto:nexus@peg.apc.org)

Web page: <http://www.peg.apc.org/~nexus/>

NEW ZEALAND OFFICE - PO Box 226, Russell,

Bay of Islands. Ph: +64 (0)9 403 8193;

Fax: +64 (0)9 403 8196;

E-mail address: [nexusnz@xtra.co.nz](mailto:nexusnz@xtra.co.nz)

USA OFFICE - PO Box 177, Kempton, IL 60946-

0177. Ph: (815) 253 6464; Fax: (815) 253 6454

E-mail address: [nexususa@earthlink.net](mailto:nexususa@earthlink.net)

UK OFFICE - 55 Queens Rd, East Grinstead, West

Sussex, RH19 1BG. Ph: +44 (0)1342 322854;

Fax: +44 (0)1342 324574;

E-mail address: [nexus@ukoffice.u-net.com](mailto:nexus@ukoffice.u-net.com)

EUROPE OFFICE - PO Box 372, 8250 AJ Dronten,

The Netherlands. Ph: +31 (0)321 380558;

Fax: +31 (0)321 318892;

E-mail address: [frontier@xs4all.nl](mailto:frontier@xs4all.nl)

STATEMENT OF PURPOSE

NEXUS recognises that humanity is undergoing a massive transformation. With this in mind, NEXUS seeks to provide 'hard-to-get' information so as to assist people through these changes. NEXUS is not linked to any religious, philosophical or political ideology or organisation.

PERMISSION-TO-REPRODUCE POLICY

While reproduction and dissemination of the information in NEXUS is actively encouraged, anyone caught making a buck out of it, without our express permission, will be in trouble when we catch them!

## Editorial

Welcome to yet another info-packed edition of NEXUS! Lots to mention in this editorial, but first I want to address the numerous overseas enquiries about the rise of the One Nation political party, reported widely in international media as an extreme-right-wing racist party. My perception is that most people who voted for One Nation were of the attitude that 'the enemy of my enemy is my friend'. In other words, I believe its votes came from people thoroughly dissatisfied with the two major political parties, who wanted to send a message of punishment. Rest assured, Australians do welcome visitors of all races and religions.

Our first article this issue addresses the Y2K Millennium Bug problem. I had given scant attention to this until recently when a growing number of net surfers suggested I check it out. It's *huge!* If you run a business, you had better get ready now! My research suggests that the powers-that-be are very concerned by this and want to fix the problem asap, but without panicking the public in the process.

The feature on the dangers of modern milk reflects how impressed I was with the book we reviewed in our last issue. Milk is no longer what it used to be, and, even if it were, new research suggests that humans should learn to wean themselves if they want to stay healthy. I thought that presenting the article in the form of letters to 'the NotMilkman', as author Robert Cohen refers to himself, was a good way for readers to see what sort of feedback he has received.

We are most pleased to be able to publish Dr Viera Scheibner's article suggesting that many, if not most, shaken-baby injuries and deaths are actually the result of adverse vaccine reactions, and not the result of parents or nannies shaking the baby. The medical authorities are going to have to address this issue, as the number of 'shaken-baby' deaths is only to going to increase, as will the number of innocent, grieving parents and child-carers who are imprisoned as a result.

I am also pleased to present, at last, an article on the Beck Zapper. This is really getting good results in neutralising HIV and other diseases. You can make your own device using the specifications provided, or you can purchase a ready-made model from a growing number of outlets around the world.

Those who remember my editorial mention many issues ago about a guy called Joe who has a 'car that runs on water' will be happy to read more about research into his fuel cells in Science News this issue. This is attracting serious attention from 'free-energy' researchers 'down under'.

We also have a fascinating article by a scientist involved in the discovery of evidence of ancient hunters in Mexico, in a place and time where they were not supposed to be. As you will read, publishing geological facts that do not concur with anthropological theory does not earn any points for an academic career.

Our Twilight Zone this edition has an intriguing series of communications sent from an alleged 'time traveller' to popular US radio talkshow host Art Bell. I note that the time traveller says the next US presidential race will include George Bush, Sr, but not Bill Clinton. I dismissed this at the time, a few months ago, but lo and behold George Bush *is* touted to run again! You just never know...

Linda Moulton Howe has graced our pages once more with a fascinating interview with yet another 'insider' who has come out of the closet on the subject of government knowledge of UFOs and extraterrestrials. No doubt you'll be reading more about this in UFO literature in the times to come.

The Internet is a curious place. Our service provider gives me a weekly list of how many people visited our web page and from what 'domain' they originated. Each country has a 'domain' name/address, i.e., 'au' is for Australia, 'com' is for a business, 'org' is an organisation, etc. Interestingly, the US military has its own domain which ends in 'mil'. I've noticed of late that the number of cyber-visitors from the US military has grown enormously. We've had several hundred military visitors this week alone! I trust they are enjoying the articles posted on our page!

Best wishes and happy reading,

Duncan

## WARRANTY AND INDEMNITY

Advertisers upon and by lodging material with the Publisher for publication or authorising or approving of the publication of any material INDEMNIFY the Publisher and its servants and agents against all liability claims or proceedings whatsoever arising from the publication and without limiting the generality of the foregoing to indemnify each of them in relation to defamation, slander of title, breach of copyright, infringement of trademarks or names of publication titles, unfair competition or trade practices, royalties or violation of rights or privacy AND WARRANT that the material complies with all relevant laws and regulations and that its publication will not give rise to any rights against or liabilities in the Publisher, its servants or agents and in particular that nothing therein is capable of being misleading or deceptive or otherwise in breach of the Part V of the Trade Practices Act 1974. All expressions of opinion are published on the basis that they are not to be regarded as expressing the opinion of the Publisher or its servants or agents. Editorial advice is not specific and readers are advised to seek professional help for individual problems.

© NEXUS New Times 1998



# Letters to the Editor ...

## Transnationals at the Trough

Dear Duncan: Further to Geoffrey Halton's note of appreciation for the "MAIgalomania!" article (Letters, NEXUS 5/04), I'd like to add my own thanks for publishing this important report.

Corporate globalisation is a complex issue, and at first glance it might be a turn-off for many people, as it was for me. But the more I've researched the subject, the clearer has it become that global economics is the "belly of the beast" and needs to be more widely understood.

I would like to recommend David Korten's book, *When Corporations Rule the World*, as an excellent introduction to the field. Korten has achieved the impossible and written a book on transnational corporations and the world's financial system that is absorbing to read. In my view it is essential reading for anyone wishing to gain an understanding of global economics, and I strongly encourage you to make it available through the NEXUS booklist.

And please keep on printing articles such as "MAIgalomania!" and the earlier "Along Came the Transnationals" (NEXUS 4/03). A worldwide movement of resistance to the power of the TNCs is gradually taking shape, and the more you can do to support it, the better.

With best wishes, Paul Swann, pswann@easynet.co.uk

## CJD/Mad Cow Connection

Hello. My name is Terry S. Singeltary Sr, and on 14 Dec. '97 my mother died of Heidenhain-van Creutzfeldt-Jakob disease, which means, as you'd know, she died a very hideous death.

The time from first symptoms to death was 10 weeks. At times she would jerk so badly it would take three of us to hold her down. First symptom was seeing brown spots; about 10 days from that she was blind. From there, it was like a wildfire in the wind. Next she starting losing her coordination, speech and, finally, her mind. About the middle of the eighth week she became comatose and died on 14 Dec. '97. Thank God!

Exactly one year to the day before my mother died, my neighbour's mother died of CJD on 14 Dec. '96.

I have autopsy reports to confirm both cases, and the Western immunoblot analysis was performed on the brain tissues of my mother at Case Western Reserve University. They came back positive for the protease-resistant prion protein (prp res.), confirming what I already knew. You only have to see it once.

Not too long ago after my mother had died, my neighbour called me and said I have to see something. He had been going through an old box of his mother's and found a bottle of pills. They were nutritional supplements, Iplex; ingredients: vacuum-dried bovine brain, bone meal, bovine eye, veal bone, bovine liver powder, bovine adrenal, vacuum-dried bovine kidney, and vacuum-dried porcine stomach. It's a cow in a pill! Now my neighbour's mother, who was taking these pills, died from CJD. She was first diagnosed with Alzheimer's until the autopsy ruled that out and ruled in CJD. The manufacturer of the pills is Standard Process, Inc., Palmyra, Wisconsin, ph 1800 558 8740.

There was a big article in the Galveston *Daily News* (Monday, April 27, 1998 issue) about all of this. After the article came out in the paper, a girl called me and told me of her father dying of CJD in late '94 or early '95 in Galveston. She told me that her father's doctor was also my mother's doctor. My mother's doctor would always mention the other case, but that was as far as it went. Now I know why! The daughter told me that her father had been a butcher at a meat market in Galveston for years. Makes me wonder...

I called the Texas Department of Health and they came the next day and got the pills. At the present time they are at NIH where a Dr Gibbs will do extensive research on them. But what bothers me the most is that the manufacturer of the pills has clammed up on the Texas Dept of Health and will not cooperate any more. They are referring all matters that pertain to this to their lawyers. How can this be?

I have very strong feelings about all of this. I will not bore you with my own theory about this disease—you know I have one and you probably already know what it is. But I know what my mother died from. It's here, and as long as they keep saying it's not here, we

will continue to see people die. The true count of this disease will never be known until they start doing more autopsies and correct the misdiagnosis of people with Alzheimer's who really have CJD, or mad cow disease. You see, I like to call it for what it really is. But you cannot put the blame on the cow; you have to blame man, because greed is what it's all about. Man started this disease and only man can end it.

I felt like I should tell you about the nutritional supplements; I thought it might be of some importance to you. Please don't hesitate to contact me if you need further info on this.

With thanks, mad son! (Terry Singeltary), flounder@wt.net

## Our Mysterious Origins

Dear Duncan: Having seen the NBC production of *The Mysterious Origins of Man*, we then read "The Controversy Over *The Mysterious Origins of Man*" (NEXUS 5/04). Angered and saddened to say the least, we were not surprised by the blinkered views of eminent professors.

We were reminded of Plato's allegory of the cave, written some 2,500 years ago, whereby the hero of the piece, after a long and treacherous struggle to discover the source of light (truth), returns to those who still inhabit the dark recesses of the cave to release them from their lifetime of bondage and chains (ignorance) and enlighten them to the fact that life as they know it is but the passing shadows of real life walking outside the mouth of the cave. This revelation serves only to frighten the inhabitants, who form an angry mob and promptly kill the hero. Then boycotting any further excursions to the mouth of the cave, the inhabitants return to their shackled, shadowed world, content that they have saved the status quo.

Plato also stated that "in the absence of the absolute, society itself becomes the absolute, governed by a small elite who manipulate the masses".

The human race has escaped from the dark ages of Machiavellian popes, embraced the Renaissance, soared through the Age of Enlightenment into a post-industrialised world—only to be plunged back into the dark ages

of an angry mob of Machiavellian profs who proclaim to "straighten out bad ideas with [their] students" and react with such fury to *The Mysterious Origins of Man*. One reason is they want control over the minds of their students—when, in reality, all they have to reveal to tomorrow's minds are but shadows of the truth.

Peter McClelland, Clyde Scorgie, cjs@ihug.co.nz

## CIA: Criminally Inept Agency

For the past 10 months on my radio show I have been raging about how expensively inept and criminal the CIA is; how completely unresponsive to Congress and the American people they are; and what grave damage they have done the nation they have sworn to serve. I guess somebody with a little clout has been listening, because finally I have lived to see mainstream media echo my sentiments, at least somewhat.

On Wednesday, June 3, the *New York Times* front page featured an article entitled "CIA Study Details Failures; Scouring of Agency Urged".

The article (written by Tim Weiner, who, as far as I'm concerned after 25 years as a federal agent and three decades as a court qualified expert in many matters pertaining to international drug trafficking, terrorism and covert operations, is the best journalist that newspaper has) reveals a classified report on the CIA's inability to foresee India's May 11 nuclear tests. And once again, Tim Weiner is the only journalist to tell the story.

The report, authored by Retired Admiral David E. Jeremiah, detailed "structural weaknesses in the CIA and its sister services that go far beyond the question of India". The report, calling this latest of a seemingly unending string of CIA failures a "debacle", concluded that:

- The CIA has little or no human intelligence (spies);
- The agency's ability to use people instead of machines to gather intelligence is weak;
- Spy satellites produce far too much intelligence for the allegedly overworked and undertrained intelligence analysts to handle;
- The CIA had an "underlying mindset" that India would never set off a bomb, that literally made

# ... more Letters to the Editor

**NB: Please keep letters to approx. 100-150 words in length. Ed.**

it deaf and blind to the massive amount of intelligence to the contrary.

Admiral Jeremiah recommended, in essence, a complete overhaul of the way CIA does its job. The Director, Central Intelligence, George Tenet—a man who was named to head CIA by President Clinton in spite of the fact that he had failed to pay federal income taxes on an inheritance of real estate and other properties from his father, claiming he didn't know he had inherited the stuff (known to us gringos as income tax evasion)—accepted the findings.

After meeting with Clinton, Mr Tenet said: "In a perfect world, the CIA would never again miss an event that changes the course of history." To which I say that the American taxpayer has a right to expect that even in an imperfect world the CIA should not miss every event that changes the course of history and damages our national security, i.e., the Islamic revolution; Afghanistan's use of drug money and CIA training to support international terrorism; Bay of Pigs; Vietnam; the collapse of Russia; the overthrow of Saddam Hussein; the fact that CIA's head of Soviet counterespionage, Aldrich Ames, was working for the KGB for eight years; the fact that CIA agents and officers have been protecting the biggest enemies of the American people in our history, from Klaus Barbie to Manuel Noriega, etc., etc. (I'm afraid I can go on for another page or two, but I think I've made my point.)

What is really sad is that this is an agency that, according to well-respected covert operation analysts, has cost the American people over \$1 trillion dollars in the past decade. At a time when our nation is 16th in the world in education, when most hard-working Americans cannot afford health care or medical insurance, when our social security system is going bankrupt and our government is looking for new ways to tax us, we should demand a lot more than we are getting.

So is it any wonder I begin each broadcast of "The Expert Witness Show" with this advice to those CIA agents assigned to tape-record the show: "Guys, don't forget, it's 'press the red button to record'."

Michael Levine, "The Expert Witness Show", WBAI, New York City, rocamora53@aol.com

## Counts of Albany Clarification

Dear NEXUS: I would like to send the following to your readers' letters section, and hope it can still be placed in the August-September edition. I always enjoy reading your publication and would like to comment on the article series of Laurence Gardner [5/02-04], also in the hope that maybe he would respond.

The position of both the author and his patron seems dependent on the claim that Bonnie Prince Charles had legitimate offspring, and notes derived from such sources as the Royal House of Stewart Jacobite Records of St Germain and the Presidential Files of the European Council of Princes. However, I, and others I've asked, have not been able to trace any of these sources.

In general, one seems to find in the history of esotericism a fascination with monarchy, particularly with deposed or missing royalty. Thus Arthur, Charlemagne and Frederick Barbarossa are all said to be sleeping in various places, waiting until their nations should need them.

Several claimants came forward after the 1578 death in battle of King Sebastian of Portugal. A messianic cult, "Sebastianism", grew up around his memory, and four false Sebastians arose at different times to claim the throne. So, too, in Russia where the same number of false Dimitris came to prominence, each claiming to be Ivan the Terrible's son who died as a boy. Much the same arose around the son of Louis XVII, Count Naudorf, who was hailed as King by many 19th-century French occultists including Eliphaz Lévi.

It was during the same period that two brothers in Scotland announced themselves to be descendants of Bonnie Prince Charlie. Although their claims were disproved, they have been remembered to history as the Sobieski-Stuarts.

Historian Hugh Trevor-Roper said that the Sobieski-Stuarts "were amiable, scholarly men who won converts by their transpicuous innocence; they were fantastic rather than forgers. They were

also genuine in the sense that they lived their own forgeries".

Brigitte Muehlegger, Vienna, Austria

[*Sir Laurence's response follows.*]

The Counts of Albany in legitimate descent from Charles Edward Stuart are detailed in numerous national archives, including the Archives Nationales de France; Archives Nationales, Bruxelles; Bibliothèque Nationale, Paris; Archivo Storico di Sardegna; and Archives Napoléon, Paris.

They have been the subject of writings and dispatches by numerous generals, cardinals, heads of state and court ambassadors including: General Giuseppe Buonaparte; René François, Vicomte de Chateaubriand, Consul of France in Rome; Baron Surlet de Choquier; Cardinale Ercole Consalvi; Cardinale Giuseppe Fesch; Victor Hugo; King Charles X of France; Hubert Pierlot, Prime Minister of Belgium; and Jules de Polignac, First Minister of France.

[*Sir Laurence then includes a list of 10 books published in French and Italian in the 1800s and early 1900s which he describes as "Of particular interest". Contact us if you'd like a copy. Ed.*]

As for the brothers, John and Charles Sobieski-Stuart, they were second-generation descendants of Charles Godefroid de Rohan-Stuart, the illegitimate son (born 1748) of Charles Edward Stuart and his cousin Marie Louise de Rohan de Montbazon. Charles Godefroid was said to have died in his infancy, but his expatriation to Britain was confirmed by Marie Louise's brothers, Ferdinand and Louis de Rohan, Barons of the Empire, when Napoleon I disinterred the empty coffin in 1809. Charles Godefroid's son was James d'Albanie, the father of the Sobieski-Stuarts.

For all those interested in the Stuart aspect of my research, I recommend *The Forgotten Monarchy of Scotland* by HRH Prince Michael of Albany (Element Books, 1998, ISBN 1-86204-234-9). This book is currently no. 2 in Scotland's bestsellers, and no. 7 in Britain's national History Books list.

Laurence Gardner, Kt St Gm., KCD, 1 July 1998

## Induced Remission Challenge

Dr Chachoua in his article on his Induced Remission Therapy (IRT) [NEXUS 5/01, 5/04] claims to have investigated many alternative medical therapies and was disappointed by them all. Apparently he has overlooked homeopathy. He should read *The Organon of Medicine*, first published by Dr Samuel Hahnemann over 200 years ago. In just the first paragraph of the 38th aphorism (out of 291) he summarised all of IRT:

"...or the new dissimilar disease is the stronger. In this case the disease under which the patient originally laboured, being the weaker, will be kept back and suspended by the accession of the stronger one, until the latter shall have run its course or been cured, and then the old one reappears uncured."

Hahnemann goes much further, showing that you can actually cure—not just achieve remission—by means of a "similar disease" caused by the properly chosen homeopathic medicine.

Dr Chachoua's work, while good, has a long way to go to catch up with the master. I recently attended a conference where an east Indian homeopathic physician convincingly showed how he was achieving 70-80% cure rates with stage 1 cancers. I will be passing along to him Dr Chachoua's \$100,000 challenge.

I personally visited the government homeopathic hospital in Mumbai, India, in 1995 and saw case histories of individuals who had originally been HIV+ and after treatment were HIV-. Even sat in on a follow-up interview and saw the healed lesions.

I would encourage you to do a few articles on homeopathy in your wonderful magazine. It is a science of medicine that has been under attack since its birth.

The AMA was formed in the 1860s with the specific intention of getting rid of homeopathy in the US—which it succeeded in doing very well until the 1960s when homeopathy finally started to make a comeback. Homeopathy is still on very shaky ground legally, here in the States, but it is accepted around the world, although not by allopathic doctors.

Roger Barr, PO Box 16068, Oakland CA 94610, USA; rrrab@compuserve.com

## BRITISH ARMY STRATEGY BEHIND "BLOODY SUNDAY"

One of the most controversial incidents in the Northern Ireland conflict—in which members of the 1st Battalion, Parachute Regiment, shot dead 14 unarmed civilians during a civil rights march in Derry City on 30 January 1972—was not a military operation which went badly wrong but a pre-planned confrontation in which civilian casualties were an integral part of the British Army's counter-insurgency strategy.

This is the conclusion reached in a 10-page unpublished article compiled and written by former *Sunday Times* journalists Murray Sayle and Derek Humphrey. It is based on evidence including contemporaneous eyewitness accounts, taped interviews and indirect contact with the IRA.

Harold Evans, the editor of the *Sunday Times* from 1967 to 1981, spiked the story and submitted the account to Lord Widgery, whose official inquiry concluded that the soldiers had opened fire only on identified targets and that many of the victims had handled explosives or guns.

The journalists' report, which has been missing for 26 years, was found in the archive of the National Council for Civil Liberties (NCCL) and recently published in the Derry-based magazine, *Fingerpost*.



The article claims that the operation was planned by the O/C 1st Para, Lieutenant-Colonel Derek Wilford, based on Brigadier Frank Kitson's counter-insurgency strategy.

Kitson was a veteran of colonial campaigns in Kenya, Malaya, Oman and Cyprus. His theories included the political control of populations, psychological warfare, and the integrated use of special units and the intelligence services.

In 1970 Kitson commanded the 39th Brigade in Belfast, where he set up a pseudo-gang, the Mobile Reconnaissance Force (MRF). Based at Palace Barracks, east Belfast, and consisting of military intelli-

gence personnel and 'turned' official IRA members, the MRF cruised the streets of west Belfast in unmarked cars and was responsible for a number of drive-by shootings of civilians which were intended to provoke the IRA into a confrontation with the army.

According to Sayle and Humphrey, Kitson's strategy was "based on the military principle that the way to bring your enemy to battle is to attack something that, for prestige reasons, he will have to defend [and] he will then be annihilated by superior strength".

The article suggests that the civilian victims of "Bloody Sunday" were not shot "in the mistaken belief that they were armed members of the IRA", but were "accept-

able casualties" in an operation which failed disastrously because the IRA refused to be drawn into an armed confrontation with the Paras.

(Source: *Intelligence*, no. 81, 8 June 1998)

## CANCER FIGHTERS ACCUSED OF SUPPRESSING CURES

Dr Robert Atkins, whose name has become a household word since the publication of his revolutionary low-carbohydrate diet, has announced: "There is not one, but many cures for cancer available."

"But they are all being systematically suppressed by the American Cancer Society, the National Cancer Institute and the major oncology (cancer) centres. They have too much of a vested interest in the status quo."

Dr Atkins said that pure politics was keeping the government from testing various nutritional therapies for cancer.

"The government has failed to sponsor new work because their advisory boards are usually made up of experts with other portfolios as well," he explained. "Many are connected with major cancer institutions. These, in turn, have a major investment in radiation-delivering equipment. Plus, American orthodox medicine has grown up under the influence of the pharmaceutical industry and its advertising."

This is significant because the drug companies could not expect to make money from nutritional therapies as only natural, biological products were involved. (Source: [www.rarebooks.net/beck/suppress.htm](http://www.rarebooks.net/beck/suppress.htm))



## "PROJECT CENSORED" 1997

The 10 "most censored" stories last year:

### 1. Clinton Administration Aggressively Promotes US Arms Sales Worldwide

The United States is now the principal arms merchant for the world. US weapons are evident in almost every conflict worldwide and reap a devastating toll on civilians, US military personnel and the socio-economic priorities of many Third World nations.

### 2. Personal Care and Cosmetic Products may be Carcinogenic

Do you use toothpaste, shampoo, sunscreen, body lotion, body talc, make-up or hair dye? These are among the personal care products the consumer has been led to believe are safe, but are often contaminated with carcinogenic by-products or contain substances that regularly react to form potent carcinogens during storage and use.

Consumers regularly assume that these products are not harmful because they believe that they are approved for safety by the US Food and Drug Administration (FDA). But although the the FDA classifies cosmetics, it does not regulate them. An FDA document posted on the agency's web home page explains that "a cosmetic manufacturer may use any ingredient or raw material and market the final product without government approval".

### 3. Big Business Seeks to Control and Influence US Universities

Academia is being auctioned off to the highest bidder. Increasingly, industry is creating endowed professorships, funding think-tanks and research centres, sponsoring grants and contracting for research. Under this arrangement, students, faculties and universities serve the interests of corporations instead of the public, in the process selling off academic freedom and intellectual independence.

### 4. The Echelon Global Surveillance System Exposed

The Echelon system, designed and coordinated by the US National Security Agency (NSA), is one of the world's biggest, most closely held intelligence projects. Unlike many of the Cold War electronic spy systems, Echelon is designed primarily to gather electronic transmissions from non-military targets: governments, organisations, businesses and individuals in virtually every country.

The system works by indiscriminately intercepting very large quantities of com-

munications and using computers to identify and extract messages of interest from the mass of unwanted ones.

Using the Echelon system, an agency in one country may automatically pick up information gathered elsewhere in the system. Thus, the stations of the junior UKUSA allies function for the NSA no differently than if they were overtly NSA-run bases located on their soil.

### 5. US Companies are World Leaders in Manufacture of Torture Devices

In its March 1997 report entitled "Recent Cases of the Use of Electroshock Weapons for Torture or Ill-Treatment", Amnesty International lists 100 companies worldwide that produce and sell instruments of torture. Forty-two of these firms are in the United States. This places the US as the leader in the manufacture of stun guns, stun belts, cattle probe-like devices and other equipment which can cause devastating pain in the hands of torturers.

### 6. Russian Plutonium Lost over Chile and Bolivia

On 16 November 1996, Russia's Mars '96 space probe broke up and burned while descending over Chile and Bolivia, scattering its remains across a 10,000-square-mile area. The probe carried about a half-pound of deadly plutonium divided into four battery canisters—and no one seems to know where they went!

This amount of plutonium has the potential to cause devastating damage. According to Dr Helen Caldicott, president emeritus of Physicians for Social

Responsibility: "Plutonium is so toxic that less than one-millionth of a gram is a carcinogenic dose." She states: "One pound, if uniformly distributed, could hypothetically induce lung cancer in every person on Earth."

### 7. Norplant: a Human Lab Experiment in the US and Third World

Low-income women in the United States and in the Third World have been the unwitting targets of a US policy to control birth rates.

A British Broadcasting Corporation (BBC) documentary, *The Human Laboratory*, accuses the US Agency for International Development (USAID) of acting in conjunction with the Population Council of New York City to use uninformed women in Bangladesh, Haiti and the Philippines for tests of Norplant.

Norplant is a set of six plastic cylinders containing a synthetic version of a female hormone. It is intended to prevent pregnancy for five years. Surgery is required for removal, at a cost far beyond the reach of low-income women.

The Norplant saga appears to have global political implications. According to the documentary, the US Government considers global population control a "national security issue" and has increased US population-control efforts around the world.

Norplant side-effects have resulted in over 400 lawsuits being filed against Wyeth-Ayerst, the maker of Norplant. These lawsuits include class actions representing over 50,000 women.

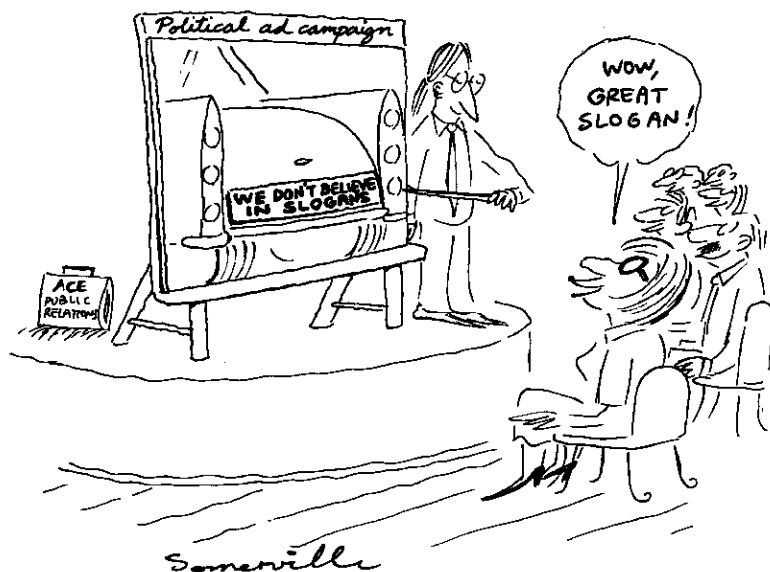

## 8. National ID Card Framework Now Established in Federal Law

In September 1996 President Clinton signed the Illegal Immigration Reform and Responsibility Act of 1996. Buried at approximately page 650 was a section that creates a framework for establishing a national ID card for the American public. This legislation was slipped through without fanfare or publicity.

The author of the national ID law, Dianne Feinstein (D-CA), stated in a Capitol Hill magazine that it was her intention to see Congress immediately implement a national identity system whereby every American would be required to carry a card with a "magnetic strip on it, on which the bearer's unique voice, retina pattern or fingerprint is digitally encoded".

## 9. Barbie's Betrayal: The Broken Workers of the Toy Industry

Thanks to the North American Free Trade Agreement (NAFTA) and the General Agreement on Tariffs and Trade (GATT), US toy factories have cut a one-time American workforce of 56,000 in half, and sent many of those jobs to countries where workers lack basic rights.

## 10. Army's Plan to Burn Nerve Gas and Toxins Threatens Columbia River Basin

Despite evidence that incineration is the worst option for destroying the nation's obsolete chemical weapons stockpile at the Umatilla Army Depot, the Oregon Environmental Quality Commission (EQC) gave the green light to the US Army and Raytheon Corporation to spend US\$1.3 billion of taxpayer money to

construct five chemical weapons incinerators.

(Source: *Project Censored*, Sonoma State University, Rohnert Park, CA 94928, USA; phone (704) 664 2500; e-mail, [project.censored@sonoma.edu](mailto:project.censored@sonoma.edu); website, <http://censored.sonoma.edu/ProjectCensored>)

## KEY PLAYERS CONTROL WORLD MONEY SUPPLY

BASEL, Switzerland — Ten times a year, the financial barons who control the world's supply of money gather here on the bank of the Rhine River for drinks and dinner—and secret conversations that shape the course of the global economy.

The 13 members of this economic cabal meet on the glass-walled 18th floor of the round headquarters tower of an obscure institution known as the Bank for International Settlements (BIS).

The members of this secretive group are the governors of the central banks of the Group of 10 industrial nations, plus Switzerland. The most powerful voice in the room is the US representative—Federal Reserve chairman Alan Greenspan. As befits its power, the United States alone has a second seat at the table, occupied by William J. McDonough, president of the New York Federal Reserve Bank. The 13th participant is the BIS general manager Andrew Crockett, a former Bank of England official.

But what, exactly, is the strangely named organisation that hosts this secret conclave?

The BIS was established in 1930 to assist in the payments of reparations owed by

Germany and other losers in World War I to the victors. Over the years it has become a central bank for central banks. It has also emerged as a clearing-house for regulators, helping them supervise commercial banks, oversee foreign exchange markets and protect the world financial system.

Historically, the BIS has been essentially a European institution with US participation. In July 1994, however, the governors of the central banks of Canada and Japan were added to its board. More recently, nine additional nations outside Europe—Brazil, Mexico, Russia, China, Hong Kong, Korea, Singapore, India and Saudi Arabia—became members, bringing the total to 41.

As a bank, the BIS has deposits of about US\$112 billion, some of which is in gold. The funds are invested with commercial banks and in securities, but central bank depositors can withdraw them at any time. Smaller central banks use the BIS both as a convenient way to invest their reserves and to keep secret the way in which they are managing the money. Last year the BIS made roughly US\$500 million on its banking activities.

All but 16 per cent of the BIS shares are owned by its member central banks. The remaining shares are in private hands as a result of the United States' failure in 1930 to pay for its shares. Instead, these were acquired by a group of American banks which later sold them, mostly to individuals in Europe.

(Source: *The Washington Post*, June 28, 1998, p. H1)

## ALTERNATIVE MEDICINE NOW USED BY 40% OF AMERICANS

Two in five Americans surveyed have turned to some type of alternative medicine not offered by their regular doctors to treat their aches and pains, says a report published by the *Journal of the American Medical Association* (19 May 1998).

The survey of roughly 1,000 randomly selected people found that those who tried alternative therapies such as chiropractic or acupuncture did so not because they were fed up with conventional medicine but because they viewed health more holistically. The survey also found that better-educated people and those with a less-than-optimum health status were more likely to turn to alternative medicine.

(Source: *Reuters*, 20 May 1998)

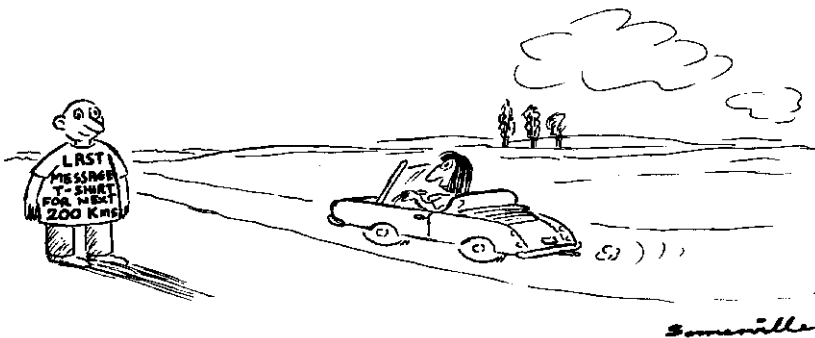



## FDA THREATENS TO BURN COOKBOOKS AND LITERATURE ON STEVIA SWEETENER

In an unprecedented move, US Food and Drug Administration (FDA) officials threatened legal action against Texas-based Stevita Co., importers of the sweet-tasting herbal dietary supplement, stevia, for distributing books and literature about their product.

On 19 May, FDA Compliance Officer James R. Lahar faxed a letter to Stevita Co., addressing the destruction of 2,500 books he deemed "offending" at a cost to the company well in excess of US\$10,000.

The letter threatens that investigators will conduct a current inventory and "witness the destruction of the cookbooks, literature and other publications for the purpose of verifying compliance" upon visiting Stevita Co. for a fourth time this year.

One of three books in question is *The Stevia Story: A Tale of Incredible Sweetness and Intrigue*, by Linda Bonvie, Bill Bonvie and Donna Gates (BED Publications Co., Atlanta, GA, USA, 1997; telephone 1800-4STEVIA).

Ironically, chapter four of the book the FDA wants to destroy is titled: "What's wrong with the FDA?" An attempt to strong-arm critics into silence, similar to book burnings in Nazi Germany?

The FDA ordered the action because the books contain general information that include history, usages and scientific studies regarding stevia. Currently, federal law requires that stevia herbal products can *only be marketed as dietary supplements without any mention of having sweetening power*.

Stevia is growing in popularity as a safer alternative to sugar. It can be obtained from many local herbalists and is easily grown in many countries.

(Source: [www.sightings.com](http://www.sightings.com))

## ED McCABE CAMPAIGN

There is a growing campaign to have Ed McCabe, noted author and lecturer on oxygen therapies, released from prison. (See Global News, NEXUS 5/04.)

The latest report is Ed has been moved from one prison to another, kept shackled (hand and foot) in solitary confinement, and strip-searched up to five times per day.

People wishing to assist with the campaign are asked to send a Notice of Complaint, which can be found on the net at <[www.cgenius.cbjd.et/mmcabe](http://www.cgenius.cbjd.et/mmcabe)>.

## THE AMSTERDAM TREATY & BRITAIN'S LOSS OF SOVEREIGNTY

By Daniel Hannan

When historians yet unborn and unbegot try to pinpoint the moment at which British sovereignty finally passed from Westminster, they are likely to choose 11.25 pm on 17 December 1997. That was when the Labour Government put through the Bill that incorporated the Amsterdam Treaty into British law.

The Amsterdam Treaty? Are there not more obvious watersheds? What about Maastricht, or the Single European Act, or even the original European Communities Act of 1972? All these were important. But Amsterdam has a better legal claim than any of them.

### Human Rights

Take, first, Article F(1). This is the clause that allows a state to have its voting rights, and any other rights derived from European Union (EU) membership, taken away by its fellow governments. In theory, this happens when the other governments judge that it is breaching certain vaguely defined human rights. In practice, it can be invoked whenever a single country is blocking a measure that all the others want. Human rights violations can always be trumped up if the political will is there. A country could be found guilty of violating the human right of its nationals to a minimum wage, or denying the human right of its homosexual citizens to serve in the Armed Forces.

The significance of this Article is that, for the first time, it allows the EU to suspend the treaty rights of a signatory while holding it to its obligations. There is no precedent for such a measure either in diplomacy or in law. Once the European treaties lose their contractual character, they cease to be a set of agreements among states and become, instead, a federal constitution.

### European Police Force

Or take the new powers granted to Europol. Europol was set up to help national police forces co-ordinate their fight against international crime, rather like a regional branch of Interpol. Europol was envisaged as a superior federal force dealing with serious crimes—a kind of European FBI. Amsterdam allows Europol personnel to take part in national policing operations. At a stroke, they are transformed from bureaucrats into policemen. This is especially significant given that Europol employees are immune to prosecution in national courts.

### Federal Institutions

Or consider the changes made to the EU's institutional structure. These follow a consciously federalist plan which envisages the Commission as Europe's cabinet, the Court of Justice as its supreme court, the Parliament as its principal legislature and the Council of Ministers as a kind of Upper House or *Bundesrat* representing the member states. Accordingly, the President of the Commission is given the power to choose his own commissioners, subject to approval by the European Parliament, exactly as national governments are drawn up, subject to being able to command a parliamentary majority. Member states consequently lose the exclusive right to nominate their own commissioners.

### A New Legal Order

But the key change, the one to which future historians will point, is tucked innocuously into the Protocol on Subsidiarity. There, in paragraph 2, is a reference to the sanctity of "the principles developed by the Court of Justice regarding the relationship between national and community law".

What this clause refers to is the doctrine developed by the European Court of Justice that its own rulings have precedence, not just over national laws but even over the constitutional or basic laws of the member states.

The European Court has never accepted the stance of the national supreme courts. It believes that its jurisdiction comes directly from the European treaties which, it holds, have created a new legal order superior to national constitutions. According to the European Court's view, it is now Europe's supreme court, since its authority does not derive from the member states but from the treaties. Once the Amsterdam Treaty comes into force, this extraordinary interpretation will have legal validity.

Although Denmark and Ireland are holding referendums on the Treaty, the Labour Government has ruled out a British plebiscite, arguing that it already has a mandate. Perhaps ministers have forgotten that the Amsterdam Summit did not take place until six weeks after the general election. The House of Lords is now the last obstacle to ratifying the Treaty. If peers were to reject it or demand a British referendum first, our unborn historians may yet conclude that the UK saw out the millennium as a sovereign state.

(Source: *Eurofacts*, 6 February 1998; published by June Press Ltd, PO Box 9984, London W12 8WZ, UK, telephone/fax +44 (0)181 7461206)







# THE MILLENNIUM BUG

## Problems and Solutions

*The so-called 'Y2K problem' is much bigger than most governments, businesses and the public realise.*

by Peter Montague © 1998

First published by  
*Rachel's Environment & Health Weekly*  
#604, 25 June; #605, 2 July 1998  
Environmental Research Foundation  
PO Box 5036  
Annapolis, MD 21403-7036, USA

**W**e've been hearing about this problem for some time now, but, like most people, we have been ignoring it. As with many problems, we clip articles about it, then file them for later reference. It's the Y2K problem. To a scientist, "Y" means "year" and "K" means "1,000", so "Y2K" refers to the year 2000 problem. It's a computer problem with possibly serious environment and health implications.

Like most people, we are very suspicious of alarming predictions about the year 2000. What finally focused our attention on the Y2K problem was a small item in the back pages of the *New York Times* of Saturday, June 13, 1998.<sup>1</sup> It began: "The nation's utilities told a Senate panel today [June 12] that they were working to solve expected computer problems when 1999 ends but that they could not guarantee that the lights would not go out on Jan. 1, 2000."

The utilities say the lights may go out. This seems like a problem worth examining.

The *Times* went on: "An informal survey by a Senate panel of 10 of the nation's largest utilities serving 50 million people found none had a complete plan in case its computers failed because of the problem." The *Times* explained: "Many electrical plants use date-sensitive software to run built-in clocks that monitor and control the flow of power. These could fail if not updated."

The utilities say the lights may go out, yet none of them has a full contingency plan. How serious could this problem become?

As we examined the items in our Y2K file, we found opinions ranging all over the place. Some people said, "This is a fake problem invented by people who want to sell fixes." Others said, "This is going to be the end of civilisation as we know it." Where does the truth lie?

I worked five years in the Computing Center at Princeton University, so have more than a passing familiarity with computers. My crystal ball is as hazy as anyone else's, but here is an attempt to offer a realistic look at the nature of this Y2K problem.

Unlike most problems, we know when this one is going to hit us: on January 1, 2000, just a little over 500 days from now.

Here is the crux. Many computers only recognise dates by two digits, e.g., 67 is 1967 and 98 is 1998. But in these computers a 00 date will mean 1900, not 2000, unless their software is rewritten. When such computers start calculating or comparing dates after 1999, they won't work right: they may simply shut down, or they may seem to run fine but produce incorrect information that is very hard to detect.

Computers that have this Y2K problem are called "non-compliant" computers, and it turns out there are quite a few of them.

Many non-compliant computers are the really big "mainframe" machines that serve as the central nervous systems of financial institutions (banks, savings & loans, credit unions), stock exchanges, air traffic control systems, missile defence systems, government tax agencies, the Social Security Administration, the Medicare program, the insurance industry, and all of the *Fortune*-1000 multinational corporations. (And of course, this problem is not limited to the US. Every industrialised country depends heavily upon large mainframe computers.)

A report published by Merrill Lynch, the financial management company, states flatly: "When the millennium arrives, many computer systems and global networks will fail because of an inability to properly interpret dates beyond 1999."<sup>2</sup>

Mainframes will not be the only computers to fail on January 1, 2000 if they are still

non-compliant by then. Many industrial machines contain "embedded systems"—computer chips that are literally embedded within some larger piece of equipment such as in power stations, oil refineries, telephone switches, burglar alarms, emergency room equipment, air traffic control systems, military defence gear and chemical plants, among others.

## EMBEDDED COMPUTER CHIPS

By the year 2000 there will be an estimated 25 billion embedded systems, according to the Gartner Group which advertises itself as the world's foremost authority on information technology.<sup>3</sup> By Gartner Group's estimate, two-tenths of one per cent of these 25 billion embedded systems will be non-compliant.<sup>4</sup> Two-tenths of one per cent of 25 billion is 50 million. Therefore the problem, according to the Gartner Group, is to identify and replace those 50 million non-compliant embedded systems in the next 500 days. To solve this problem, someone would have to identify, replace and test about 100,000 chips each day between now and December 31, 1999. Does the US have enough technicians to identify, replace and test 100,000 chips each day? It seems unlikely.

These embedded systems tend to be in the nation's core infrastructure: in the water, sewage and electrical utilities, in railroads and other transportation systems, in hospitals, in police and fire services, in the defence infrastructure, and in petrochemical and other manufacturing plants. But non-compliant computer chips are also embedded in equipment such as photocopiers, telephones, elevators, traffic lights, electric generating plants and nuclear missiles, and they all need to be fixed or replaced.

*Byte* magazine, a technical computer journal, calls Y2K "a crisis without precedent in human history". It recently reported: "One commonly cited problem is associated with gadgets that monitor periodic maintenance. When the clock strikes 12 midnight on New Year's Eve, 2000, these devices might think it's been 99 years since their last maintenance, realize that's too long for safe operation, and shut down."<sup>5</sup>

*Fortune* magazine calls it "the biggest screw-up of the computer age"<sup>6</sup> and says it may cost US\$1 trillion to fix. (The Vietnam War cost half that much—US\$500 billion.)

The Electric Power Research Institute (EPRI)—a trade association for electric utility companies—says the Y2K problem will begin to disrupt businesses, including electric utilities, a year before the new century begins. "Major disruptions in technical and business operations could begin as early as January 1, 1999. Nearly every industry will be affected," EPRI says.<sup>7</sup>

Virginia Hick, who writes a column called "Technology and You" for the *St Louis Post-Dispatch*, recently interviewed Peter de Jager, a well-known Y2K consultant to industry. Here is what Hick wrote:

"...de Jager talked recently with an executive of a company that makes a volatile gas—he would not identify the company more specifically—who told de Jager how his plant discovered the seriousness of faulty embedded chips.

"The plant found a chip that failed when the date was moved forward. When the chip failed, it shut off a valve that would have shut down the cooling system. A cooling system shutdown, the

executive said, would have caused an explosion.

"That was great news," de Jager said. "Because they checked, there will be no explosion. They're replacing the chips."

"De Jager worries about the companies that are not checking," Hick wrote.<sup>8</sup>

Conclusion No. 1: If we lived in a community with one or more chemical plants, we would be asking our local government to hold public hearings on the Y2K problem, seeking public assurances from local plant managers that they really have this problem under control. What written plans do they have for assessing these problems, and how large a budget have they committed to solving them? What progress can they demonstrate? Does the plant manager have sufficient confidence in the plant's safety systems to be at the plant with his or her family at midnight, December 31, 1999, to celebrate the new year?

## PROGRESS REPORT

Now let's return to the mainframe problem. Because non-compliant computers could harm a company's financial picture (up to and including bankruptcy), on January 12, 1998 the US

federal Securities and Exchange Commission (SEC) issued "SEC Staff Legal Bulletin No. 5" which requires publicly held companies to report their progress towards solving their Y2K problems.

On June 10, 1998 Steve Hock, president of Triaxsys Research in Missoula, Montana, testified before the Senate Banking, Housing and Urban Affairs Committee that his company had examined the SEC filings of America's 250 largest corporations.

Mr Hock told the Senate that 114 of the 250 companies had filed no Y2K information with the SEC. Of the 136 companies that *have* filed Y2K information, 101 reported their progress on the assessment phase of the problem. Of these 101, 60 per cent revealed that they have not yet completed their assessments of the Y2K problem.

Mr Hock testified that 36 companies reported their estimated Y2K project costs and how much they had so far spent. The average company reported having spent 21 per cent of the expected total costs of Y2K fixes. Mr Hock concluded: "[The] data show remarkably little progress by the largest US companies in addressing the year 2000 problem. Most of the work has been compressed into an extremely tight window of time. Given the information technology industry's long history of failure to complete large-scale system conversion projects on time, this is cause for serious concern."<sup>9</sup>

The New York Federal Reserve Bank has said that it will take more than a year for a large corporation to test its computers for Y2K compliance *after* all their software has been fixed.<sup>10</sup> This means that all fixes must be completed by September or October of 1998 so testing can begin in time. But many large corporations are still at the stage of assessing the problem, and it's now late June [at the time of writing].

How big is the task for a complex corporation? State Farm Insurance—a company that believes it is on top of the Y2K problem—began working on the problem in 1989 and found that it had 70 million lines of computer code to convert, 475,000 data processing items, more than 2,000 third-party software programs, 900 shared electronic files, plus miscellaneous telephone and

**...non-compliant computer chips are also embedded in equipment such as photocopiers, telephones, elevators, traffic lights, electric generating plants and nuclear missiles...**

business equipment in 1,550 corporate and regional service facilities. State Farm still has 100 employees working "around the clock" on nothing but Y2K.<sup>11</sup>

But even a forward-looking company like State Farm could be harmed by this problem if its customers, suppliers, partners, bankers and regulators aren't compliant by the year 2000. As Merrill Lynch says: "Even institutions that have fixed their own internal problem will feel the ripple effects from problems occurring externally."<sup>12</sup>

A survey of small businesses by the National Federation of Independent Businesses (NFIB) reported on June 1 that 75 per cent of small businesses have done nothing about the Y2K problem. The NFIB estimates that 330,000 small businesses will go bankrupt and another 370,000 will be "temporarily crippled" by the Y2K problem.<sup>13</sup>

Conclusion No. 2: Portions of the nation's basic infrastructure (utilities, transportation, defence, manufacturing) seem likely to be disrupted by the Y2K problem. Furthermore, parts of the world's core commercial institutions, such as banking and insurance, also seem likely to be disrupted.

### ANTICIPATED EFFECTS

If the disruptions don't begin on January 1, 1999, they may begin on July 1, 1999 when fiscal year 2000 begins for 46 out of the 50 states, or on October 1, 1999 when fiscal year 2000 begins for the federal government. But most of the problems will probably surface after midnight on December 31, 1999.

Charles Rossetti, commissioner of the US Internal Revenue Service (IRS), told the *Wall Street Journal* in late April that Y2K is a "very, very serious problem". "There's no point in sugar-coating the problem," he said. "If we don't fix the century-date problem, we will have a situation scarier than the average disaster movie you might see on a Sunday night. Twenty-one months from now, there could be 90 million taxpayers who won't get their refunds, and 95 per cent of the revenue stream of the United States could be jeopardized."<sup>14</sup> Mr Rossetti went on to say he is confident that these problems will not occur because IRS computer experts will prevent them. Critics of IRS are not so sure.<sup>15</sup>

The deadline for having everything fixed—December 31, 1999—is just over 500 days away, and it is an unusual kind of deadline because it cannot be ignored or extended.

*Fortune* magazine (April 27) reported that, on average, large corporations are only 34 per cent of the way through the job of making their systems compliant.<sup>16</sup>

Government agencies are doing only slightly better. The Government Accounting Office (GAO) stated in March 1998: "Time is running out for solving the Year 2000 problem. Many federal agencies will not be able to renovate and fully test all of their mission-critical systems and may face major disruptions in their operations. At the same time, systems that have been renovated and tested may encounter unanticipated Year 2000 problems."<sup>17</sup>

The GAO gave examples of what may go wrong:

- The nation's air transportation may face major delays and disruptions because the airlines may not be able to file flight plans

with the Federal Aviation Administration.

- Taxpayers may not receive timely tax refunds because the IRS may be unable to process their tax returns.

- Payments to veterans and retirees may be delayed or disrupted by the failure of mission-critical systems supporting the nation's benefit payments systems (i.e., people may not receive their social security or disability checks in a timely fashion).

GAO reported on June 10 that 24 government agencies are only 40 per cent of the way towards their goal of Y2K compliance.<sup>18</sup> GAO said it had published 40 reports on government computers during the past two years: "The common theme has been that serious vulnerabilities remain in addressing the federal government's Year 2000 readiness, and that much more action is needed to ensure that federal agencies satisfactorily mitigate Year 2000 risks to avoid debilitating consequences." GAO concluded: "As a result of federal agencies' slow progress, the public faces the risk that critical services could be severely disrupted by the Year 2000 computing crisis."

No one knows what will happen as we approach the year 2000.

We do know that many manufacturing processes are dependent upon computers, especially in the chemical processing industries. The *Fortune* report said: "The precision and interdependence of process controls in chemical plants, for instance, make a Rube Goldberg fantasy contraption look simple. Let a single temperature sensor in the complex chain of measuring instruments go cuckoo because of a year 2000 problem, and you'll get a product with different ingredients than you need—if it comes out at all."<sup>19</sup>

Even the nation's defence apparatus could be adversely affected. The GAO reported on June 30 that the US Navy is far behind in fixing its Y2K problems, and concluded: "Failure to address the year 2000 problem in time could severely degrade or disrupt the Navy's day-to-day and, more importantly, mission-critical operations." GAO said the navy doesn't

even know how many of its computers have Y2K problems, so it doesn't know how big the task ahead may be.<sup>20</sup>

Why is this seemingly simple problem so difficult? Merrill Lynch, the financial management firm, says there are four reasons:<sup>21</sup>

1. Pervasiveness. Computers that depend on dates are present in every kind of technology—manufacturing systems, medical equipment, elevators, telephone switches, satellites and even automobiles.

2. Interdependence. Computers exchange information among themselves. "A single uncorrected system can easily spread corrupted data throughout an organization and even affect external institutions," Merrill Lynch says.

3. Inconsistency. Computer languages do not store and use dates in a consistent way. Dates are labelled, stored and used in different ways from program to program and even within a single program. Therefore, identifying and correcting dates requires close inspection of the computer code line by line.

4. Size. Most large corporations and government agencies use thousands of programs containing millions of lines of computer code. Each line of code must be inspected manually and, if necessary, fixed.

**"If we don't fix the century-date problem, we will have a situation scarier than the average disaster movie you might see on a Sunday night."**

— Charles Rossetti, commissioner of the US Internal Revenue Service (IRS)

## AND THAT'S NOT ALL...

There are additional reasons why this is a particularly difficult problem. Many business computer programs that run on the largest ("mainframe") computers are written in an obsolete language called "COBOL". COBOL hasn't been taught for 10 years, so there is a distinct shortage of COBOL programmers.<sup>22, 23</sup>

Indeed, there is a shortage of all programmers to work on Y2K problems. Swiss Re (a firm that insures insurance companies against major losses) says: "A total of well over three million programmers would be needed to solve the millennium [date] problem in the US. In actual fact there are only around two million of them at present."<sup>24</sup>

When computer code is rewritten, new errors are introduced at an average rate of one new error in every 14 lines of rewritten code. Thus even "Y2K-compliant" code may not work properly when the time comes.<sup>25</sup>

Therefore, we believe it is reasonable to conclude that portions of the nation's critical infrastructure (water, electricity, telecommunications and transportation) may be disrupted for a period; perhaps a few days, but conceivably longer. Essential government services may also be disrupted.

We could be entirely wrong. However, we believe it is sensible to hope for the best but prepare for the worst.

Individuals might take precautions to protect themselves and their families. They need water, food, shelter and a cash reserve.<sup>26</sup> They need paper records of bank accounts and insurance policies in case computerised records are lost.

But even more importantly, communities need to begin now to think about ways to mitigate these problems. All is not lost. Much trouble can be averted by focused efforts now.

Awareness is the first issue. A recent survey of 643 individuals found that 38 per cent had never heard of the Y2K problem. Among the 400 (62 per cent) who *had* heard of it, 80 per cent said they believed it would be fixed before the year 2000 arrived. This contrasts with an earlier poll of technology and business executives charged with fixing Y2K problems: only 17 per cent of them said they thought the problems would be fixed before the year 2000.<sup>27</sup> People need to be told.

Coordinated action is the second issue. People need the resources to be able to fix their own computers.<sup>28</sup>

Thirdly, communities need to think creatively about ways to help those who are most vulnerable: people who rely on social security, veterans benefits and private pensions, for example. What will happen if their funds are delayed? Local govern-

ments, churches and civic groups could begin now to bring communities together to find ways to avert serious problems that might occur. Approached properly, Y2K could become a catalyst for positive community growth and development in the best sense of those words.<sup>29</sup>

### About the Author

Peter Montague is Editor of *Rachel's Environment & Health Weekly* and a member of the National Writers Union.

...it is reasonable to conclude that portions of the nation's critical infrastructure (water, electricity, telecommunications and transportation) may be disrupted for a period...

### Endnotes

1. "Utilities Say Outages Are Possible in 2000", National News Briefs, *New York Times*, June 13, 1998, p. 16.
2. See <[www.ml.com/woml/forum/millen.htm](http://www.ml.com/woml/forum/millen.htm)>.
3. See <<http://gartner12.gartnerweb.com/public/static/home/home.html>>.
4. Thanks to Raleigh Martin for the Gartner Group estimate. See <[http://ourworld.compuserve.com/homepages/roleigh\\_martin/y2journ.htm](http://ourworld.compuserve.com/homepages/roleigh_martin/y2journ.htm)>. The most comprehensive, and most pessimistic, web page on Y2K is that of historian Gary North; see <[www.garynorth.com](http://www.garynorth.com)>.
5. DeJesus, Edmund X., "Year 2000 Survival Guide", *Byte*, July 1998, pp. 52-62. Good websites covering this problem include: <<http://www.yourdon.com>>; <[www.euy2k.com](http://www.euy2k.com)>; <<http://www.year2000.com>>; <[www.y2ktimebomb.com](http://www.y2ktimebomb.com)>; <[www.garynorth.com](http://www.garynorth.com)>.
6. Bylinsky, Gene, "Industry Wakes Up to the Year 2000 Menace", *Fortune*, April 27, 1998, pp. 163-180. Available on the web at <[www.pathfinder.com/fortune/1998/980427/imt.html](http://www.pathfinder.com/fortune/1998/980427/imt.html)>.
7. See <<http://year2000.eprweb.com/year2000/challenge.html>>.
8. Hick, Virginia, "Expert Warns Computer World is Running Out of Time to Meet 2000: Code is Broken and Needs to Be Fixed Fast, He Says", *St Louis Post-Dispatch*, November 19, 1997, p. C8. See also <[www.year2000.com](http://www.year2000.com)>.
9. Mr Hock's testimony is available at <[http://www.senate.gov/~banking/98\\_06hrg/061098/witness/hock.htm](http://www.senate.gov/~banking/98_06hrg/061098/witness/hock.htm)>.

10. See <[www.ny.frb.org/docs/bankinfo/circular/10937.html](http://www.ny.frb.org/docs/bankinfo/circular/10937.html)>.
11. See <[www.statefarm.com/about/year.htm](http://www.statefarm.com/about/year.htm)>.
12. See <[www.ml.com/woml/forum/millen.htm](http://www.ml.com/woml/forum/millen.htm)>.
13. See <<http://www.amcity.com/sacramento/stories/060198/smallb2.html>>.
14. Tom Herman, "A Special Summary and Forecast of Federal and State Tax Developments", *Wall Street Journal*, April 22, 1998, p. A1.
15. Pejman, Peyman, "Industry rep voices doubt over federal 2000 readiness", *Government Computer News*, June 15, 1998. See website <[www.gcn.com/gcn/1998/June15/industry\\_rep\\_voices\\_doubt\\_over\\_f.htm](http://www.gcn.com/gcn/1998/June15/industry_rep_voices_doubt_over_f.htm)>.
16. Bylinsky, *Fortune*, *ibid*.
17. Willemssen, Joel C. and Keith Rhodes, "Year 2000 Computing Crisis: Business Continuity and Contingency Planning", GAO/AIMD-10.1.19, General Accounting Office, Washington, DC, March, 1998. Available at <[www.gao.gov/y2kr.htm](http://www.gao.gov/y2kr.htm)>.
18. Willemssen, Joel C., "Year 2000 Computing Crisis: Actions Must Be Taken Now to Address Slow Pace of Federal Progress", GAO/T-AIMD-98-205, General Accounting Office, Washington, DC, June 10, 1998. Available at <[www.gao.gov/y2kr.htm](http://www.gao.gov/y2kr.htm)>.
19. Bylinsky, *Fortune*, *ibid*.
20. Stephenson, John B. et al., "Defense Computers: Year 2000 Computer Problems Put Navy Operations At Risk", GAO/AIMD-98-150, General Accounting Office, Washington, DC, June 1998. Available at <[www.gao.gov/y2kr.htm](http://www.gao.gov/y2kr.htm)>.
21. See <[www.ml.com/woml/forum/millen.htm](http://www.ml.com/woml/forum/millen.htm)>.
22. Bylinsky, *Fortune*, *ibid*.
23. Chandrasekaran, Rajiv, "Older Programmers

- May Fix Future", *Washington Post*, March 2, 1997, p. A1. See <[www.washingtonpost.com/wp-srv/frompost/features/mar97/2000.htm](http://www.washingtonpost.com/wp-srv/frompost/features/mar97/2000.htm)>.
24. See <[www.swissre.com/download/public/millene.pdf](http://www.swissre.com/download/public/millene.pdf)>.
25. Bylinsky, *Fortune*, *ibid*.
26. See <[www.y2kwomen.com](http://www.y2kwomen.com)>. If you need this "how to protect your family" information sent to you by mail, send US\$2.00 to ERF to cover postage and copying (in the US); we'll mail you 27 pages of information. Please mark your envelope "Y2K".
27. Susan Watson [(508) 935 4190] and Karen Fogerty [(508) 935 4091], "CIO Magazine Study Shows Many Consumers Clueless About Year 2000 Computer Glitch", press release dated June 12, 1998. See <[www.cio.com/marketing/releases/y2k\\_release.html](http://www.cio.com/marketing/releases/y2k_release.html)>.
28. DeJesus, *Byte*, *ibid*.
29. See, for example, Robert Theobald's work on community responses to Y2K: <[www.transform.org/transform/tlc/Resiliency.htm](http://www.transform.org/transform/tlc/Resiliency.htm)>.

### Note:

Environmental Research Foundation provides this electronic version of *Rachel's Environment & Health Weekly* free of charge, even though it costs considerable time and money to produce it. Please send your tax-deductible contribution to: Environmental Research Foundation, PO Box 5036, Annapolis, MD 21403-7036, USA. For further information, phone ERF toll free on 1888-2RACHEL (USA only), or (410) 263 1584, or fax on (410) 263 8944.



**T**he Center for Strategic and International Studies (CSIS), a Washington, DC, think-tank, held a conference on 2 June 1998 titled "The Y2K Crisis: A Global Ticking Time Bomb". To complete our Y2K coverage for now, the following is an edited transcript of a conference address given by Mr Alan Simpson on the subject of "Global Food Chains". He is introduced by the conference co-chairman, Mr Arnaud de Borchgrave, director of the CSIS Global Organized Crime Project.

— Editor

**Arnaud de Borchgrave:** Alan Simpson has conducted briefings and presentations in over 60 countries, and since 1995 this England-born computer and communications advanced technologist has been a leading spokesman on international year 2000 issues.

After 10 years of service with Royal Air Force Intelligence in the UK, where he specialised in electronic warfare, Mr Simpson formed Proloc Computers and Cambridge Advanced Technology. He was a pioneer in advanced communications networks. As president of Satellite Communications Limited, he was one of the early birds in global satellite communications in television, and was awarded nine US Government contracts for satellite links to US embassies.

Mr Simpson also helped develop USIA's much-acclaimed WorldNet during the Reagan administration. He has been a consultant to CNN, BBC, VOA and 13 start-up networks. Since 1995, Mr Simpson added the development of TV news programs to his activities, producing and hosting *Wildfire* and *Countdown 2000*.

Today he will tell us about the Y2K connectivity problem, or what he calls "the global food chain".

**Alan Simpson:** Thank you, Arnaud.

The year 2000 problem is a global problem. One of the things we've heard said here today, which is spoken a lot in the media, is that the United States is ahead of the rest of the world. Correct. But also it's more dependent on technology than the rest of the world. So while we are ahead in awareness, the effects will be more pronounced here than anywhere else in any country.

Some Third World countries won't even notice it. Other Third World countries, because they use hand-me-down computers from the West, will come to a grinding halt.

The food chain...I'm not speaking about food. The real title should be "the global supply communications and logistics web". But that puts people to sleep, so we call it "the food chain" and then you think you're getting a cooking program.

As an aside from that, since we've been doing this now for about three months, a lot of farmers have contacted me saying, "Are you talking about the real food chain?" And in the first days I said, "No, no, no. We're talking about the relationship between government, major corporations, small corporations and the communications infrastructure." "Oh," said they. "Well, we've got a problem."

A few weeks ago we started looking at this, and it was Bruce Webster [from Object Systems Group] who mentioned in one of his presentations the could-be famine in the United States in 2000. And, like most of you here, I thought, "Rubbish, rubbish!"—until we started looking at the infrastructure and started the wildfire scenarios on "What if?". And looking at New York and

California, I walk into a supermarket and I get lettuce, fresh vegetables, any day of the year. Seven days ago they were in a field in California. Now they're in a supermarket just outside New York.

We know the switches on the railroads are faulty. We know because of mergers that even today many of the major corporations in the railroad business don't know where the railway stop is.

When you move this way through, come 2000 you could have a scenario—and when you look at this, it's the Soviet Union in the

1980s—where there's plentiful supply of food in the fields, but you can't get it from the fields to the towns to feed the population. This is not a way-out, whacko scenario. This is for real.

Back to the food chain. When you have a look at it, it's a three-dimensional model. You've got the governments, the major banks, the major corporations, medium and small businesses and mom-and-pop operations. Year 2000 is going to affect this vertical food chain differently at different levels.

Governments have got the resources, but they're sitting around. We are telling each other we're going to be compliant. Yeah, we trust the Pentagon. Yeah, yeah. They're going to be compliant. When we look at the major corporations and the banks, they have the resources and the manpower to correct the problem. Way at the bottom, mom and pop. They can go to manual. Most small businesses can switch their computers off and use pen and pad and go to manual.

But in the middle they have the most problems. And currently, the medium and larger small businesses are being totally neglected with information on year 2000. We focused on the banks. We

**We don't scream and shout this out because we don't want the world to know this.**

focused on Wall Street. We focused on General Motors. We have forgotten about the 23 million small and medium businesses that make up the food chain that supplies General Motors.

So, what have they been sold? Over the '80s they have been sold "just in time". You don't hold stocks. You've all seen the Federal Express ad: all the workers just stand around, and up comes the Fed Ex truck just in time. Most of industry today is waiting for UPS, Fed Ex or someone to come in early, first thing in the morning, to give them work, and they work that day. They don't have stocks. We don't have a stock of strategic commercial materials to keep the country running for one or two months. Everything is just in time: straight out of the ground—they advance shipping and air, communications—straight into the factories. We know that is not going to work. We know! This is not a doomsayer!

We can even tell you the model numbers on the switchers that won't work in the telecommunications network. We can tell you

where they are, and at the moment we know exactly the percentage of the telecom network that will fail. We don't scream and shout this out because we don't want the world to know this. Looking around the world, other countries are in an even worse mess.

But as far as communication is concerned, and I know there are communications people in the room, the year 2000 problem will be the *third* problem between now and 2000.

First, there will be the peak of the micrometeorite shower as predicted by NASA. This event could seriously affect space assets such as telecommunications satellites. There is the possibility that there could be no effect. Every piece of dust or debris could miss the hundreds of orbiting satellites, or impact with little effect. The worst case scenario is that a number of satellites, with their data and voice circuits, could be destroyed or crippled. We need to ensure that the vulnerability lessons learned from *Galaxy IV*—which took out most of the pagers across the United States—have not been forgotten.

The next NASA-predicted event is "Solar Max 23", where the Sun reminds us that it controls our life on Earth. This burst of energy could have tragic, or little effect on the satellites spared by the micrometeorite onslaught. This event, like earlier solar maximum events, could cause disruption in power grids.

Oh, we can use backup power. Problem: the fuel for the backup power is in the ground in tanks. We cannot pump fuel out of underground tanks. If you don't believe me on this, go around to your local filling station. Ask them to take off the panel and show you where the old crank is. In the old pumps, when the power failed you pulled up the front panel, stuck in a starter handle and you could pump for the ambulances and the fire—whatever you wanted. They've taken those out.

Going back to the rail system, they've taken out manual points. I talked to some of the major rail companies a few days back and said, "Go to manual." And they said, "All our manual points are in the warehouse up in New York State waiting to be disposed of. We cannot switch manually any more. We have taken out manual reversion systems on most of our key communication, power and switching systems."

So, let's have a look at the communications. Without power and without communications, you can be totally compliant. You can have computer software. It doesn't matter. What can we do about this? We need to start looking seriously and get some true answers.

I met with John Koskinen of the White House yesterday, and we were running through the problems that he had. And the problems that he had are the same as Senator Bennett said [in his presentation]: no one is telling 100 per cent of the truth. Everyone is frightened about their stock position. Everyone is frightened about their credit rating.

I look at the FAA [Federal Aviation Administration]. They're going to get their mainframes delivered—30 of them—in November. They're going to install the software, and they're going to have the system up and running by December. Wow. Let's sell tickets and watch them! [Laughter]

It takes 18 months to put a mainframe on line. And these people are going to do it in 18 days. And I'm going to fly in 2000? Yeah, right. [Laughter]

Come 2000, on the subject of flying, most of the airlines are going to have a 14-day period where the insurance companies will not let them fly. These are real figures.

The legal problem with the year 2000 is probably about US\$2 or \$3 trillion in litigation. So far, there are 189 lawsuits being settled out of court. Everyone is liable. Anyone with a name that ends in "president" or "officer" is going to be sued; not *may* be sued, *is* going to be sued. The lawyers today are forming task forces. They are set up like military task forces and they are going for class actions. They are going to retire on this.

The year 2000 problem, as far as executive concern goes, is straight negligence. You have known about this for 30 years, and you've done nothing about it. Straight negligence. It's not an act of God. It's man-made.

Not only are communications and power affected. Alarm systems are affected. Security systems are affected. If you want a real wake-up call, how about a look at the threat analysis at one minute past midnight on day one of the year 2000. A lot of the alarm systems in the banks and buildings will be neutralised.

Go back to your offices today and just sit and look around where you have a date/time group; anything on your desk with a date/time group; communications.

Every time you scan your card or put up a palm print, have a look at the printout that comes out on the log. You'll see a

date/time group. You request access, cipher, you access it and go. Denied. Go back to the beginning with that date/time group and put two zeroes in there and see what happens. The chances are it will read as an error signal and won't let you in.

Come the year 2000, the security systems in a lot of buildings will not let you in. Passwords are normally for three months and then they're wiped out of the system if they're not used for three months, a month or whatever—depends on how high the security system is. If you crank it

forward to 2000 and press the button, you find out no one can get back into it. It won't let you in.

We have created very sophisticated electronic locks on a lot of our communications and access things. They are going to come back and bite us. We have created 2000. We have created a lot of problems.

The communications stuff I don't want to go into too deeply. I would love to do a presentation on communications. But, unfortunately, it'll go out in the world. I don't want every 14-year-old hacker looking and saying, "Well, let's hit a bank. Hey, dude, let's go." That is going to happen. That is the threat side of 2000.

Back to the food chain. So we have a very fragile food chain that goes down. We have communications, we have infrastructure going across.

So the last thing then is this: failure is not an option. Everyone in this room, from government to leadership, has to meet the deadline. Failure for year 2000 is not an option.

#### Editor's Note:

For the complete transcript of the CSIS conference presentation, visit website <[www.csis.org/html/y2ktran.html](http://www.csis.org/html/y2ktran.html)>, or write to Center for Strategic and International Studies, 1800 K Street, NW, Washington, DC 20006, USA. Also see Alan Simpson's website, <[www.comLinks.com](http://www.comLinks.com)>.

**Anyone with a name that ends in "president" or "officer" is going to be sued; not *may* be sued, *is* going to be sued.**





# SPOOKS, WHISTLEBLOWERS AND FALL GUYS

**Whistleblower  
Rodney Stich  
exposes the crimes  
and entrenched  
corruption behind  
the scenes of US  
government, big  
business and the  
intelligence  
community.**

**Part 1 of 2**

**by Uri Dowbenko © 1998**

"alt.media"  
PO Box 43  
Pray, Montana 59065, USA  
Website:  
u.dowbenko@http://www.mailcity.com

In his monumental book, *Defrauding America*, former US Federal Aviation Administration (FAA) investigator Rodney Stich writes: "After Clinton was elected President of the United States, his administration and its Justice Department halted all investigations and prosecution of the crimes related to Inslaw, October Surprise, CIA drug trafficking and money laundering, BNL, BCCI and Iraqgate.

"Clinton had much to hide when he left Arkansas to assume the presidency of the United States," Stich continues. "His misuse of government facilities and power to feed his sex drive, his use of drugs, his cover-up of the CIA's unlawful arms shipments from Arkansas and related drug trafficking, were crimes. The mysterious deaths, killings and beatings of people possessing information that would expose these corrupt activities added further to Clinton's problems. He certainly needed a thick armor of protective officials in government. Fortunately for him, the US media kept the lid on these major crimes."

That must be what they mean by "Don't ask, don't tell".

*Defrauding America*, Stich's classic study of 20th-century history, contains hard evidence of state-sponsored terrorism by the US Government. In fact, the cross-corroborated testimony of over three dozen federal agency whistleblowers contributed to the unprecedented information in this astounding book.

## DOES "CIA" STAND FOR "COCAINE IN AMERICA"?

In a chapter called "Evidence on Top of Evidence", Stich recounts the testimony of veteran FBI Special Agent Richard M. Taus who recalls uncovering and reporting evidence of CIA drug trafficking by a group called "K-Team".

According to Stich: "The K-Team had a front operation with the patriotic-sounding name, National Freedom Institute, and called its operations 'the Enterprise'. Taus said that this was 'the Enterprise' that repeatedly surfaced in the Iran-Contra congressional hearings... Taus' team discovered that the K-Team was a CIA operation, and that it was engaged in drug trafficking, looting of savings and loans, and activities related to what later became known as Irangate and Iraqgate."

Another of Stich's informants, Gene "Chip" Tatum, confirmed these allegations. He was the helicopter pilot who actually ferried Oliver North, Felix Rodriguez (aka Max Gomez) and William Barr (attorney of the CIA's Southern Air Transport and later US Attorney General under George Bush) in Central America.

Tatum, according to Stich, described one meeting that was held "to determine where over \$100 million in drug money disappeared on the three routes from Panama to Colorado, Ohio and Arkansas. This theft was financially draining the operation known as 'the Enterprise'... The first call was made by Fernandez to Oliver North, informing North that 'the money loss was occurring on the Panama to Arkansas route, and that means either Seal, Clinton or Noriega'."

No honour among thieves, since CIA pilot Barry Seal, Arkansas Governor Bill Clinton and Panama's General Manuel Noriega were all suspected of skimming George Bush's cocaine profits. And here's how the Dixie Mafia and the Yankee Mob work together, according to Gene "Chip" Tatum.

"Fifteen minutes later, the portable phone rang and Vice-President George Bush was on the line talking to William Barr," Stich records. "Barr said at one point, referring to the missing funds, 'I would propose that no one source would be bold enough to siphon out that much money, but it is more plausible that each [is] siphoning a portion, causing a drastic loss'..."

"Tatum said that Barr then dialed another number, immediately reaching then-Governor Bill Clinton. Barr explained the missing money problem to Clinton...that over \$100 million of 'Enterprise' monies had disappeared along the Arkansas end of the Panama to Arkansas route, and that he and Oliver North would continue investigating the Panama end of the connection, warning that the matter must be resolved or it could lead to 'big problems'."

The problems were evidently ironed out. Bill Clinton became President—one of the CIA's "few groomed men" who was promised his position on the "shortlist" for the job, according to Terry Reed and John Cummings, authors of *Compromised*.

In another instance, Tatum flew the group to Santa Ana, Honduras, meeting with Enrique Bermudez and other Contra leaders and visiting a cocaine processing facility.

"Tatum described the strong smell of jet fuel and acetone, and the large fuel pods that had the tops stripped off them and in which were fuel and leaves," writes Stich. "Tatum repeated what Oliver North said: 'One more year of this and we'll all retire'... [Or, if not retirement, how about an Ollie North syndicated radio talk show? Or what about a run for senator, maybe even President—on the anti-drug, law-and-order platform? The hubris of these criminals is unbelievable.] North added, 'If we can keep those Arkansas hicks in line, that is'—referring to Barry Seal and Governor Clinton..."

"As Tatum listened to these conversations, he remembered the army officers' remarks...when Tatum complained about the carrying of drugs: 'Tell no one. There's no one big enough in your chain of command.'"

No kidding. Hearing Oliver North discuss the involvement of George Bush and Bill Clinton in drug smuggling, Tatum wisely followed this advice.

## STICH VERSUS THE SYSTEM

Former US Government investigator Rodney Stich is one of today's unsung heroes. His singleminded dedication in exposing government crimes and cover-ups has resulted in his own harassment, imprisonment and bankruptcy. His story will remind you of the persecution of dissidents in the former Soviet Union. Hounded and nearly destroyed by government agents in today's National Security State of America, Stich has nevertheless persevered.

His 753-page book, *Defrauding America* (in its third expanded and revised edition) is clearly a labour of love. It also happens to be the definitive history of crime, corruption and cover-ups by the US Federal Government in the 20th century. This book is not merely important; it is indispensable for every person who wants to know the behind-the-scenes manoeuvres of big government, big business and organised crime—in many instances, different branches of the same beast. Future generations will regard this book as an historical milestone like Edward Gibbon's *Decline and Fall of the Roman Empire*. Why? Because *Defrauding America* contains prima facie evidence of legal and judicial corruption so horrendous and so monstrous as to defy imagination.

And how did it happen? Rodney Stich used to be a Federal Aviation Agency investigator. After many years and continuous reports of airline maintenance abuse and negligence, he became a whistleblower; but because of the powerful forces he had chal-

lenged, he was set up, falsely charged and imprisoned.

During his "diesel therapy"—being constantly moved from one prison to another so there would be no time for him to file court appeals—he met and interviewed other whistleblowers from other US Government agencies. He accumulated more and more information and was able to write and publish *Defrauding America*.

In a recent interview, Stich said: "My initial imprisonment was due to so-called contempt of court. As you may know, I had discovered extremely serious government misconduct related to a series of air disasters. That started me into becoming a kind of an activist in government corruption.

"As I was aggressively pursuing this and acquiring more information from other government agents over a period of years, I started discovering other forms of government corruption. Involved with all of this was the United States Justice Department

cover-up which I've encountered for the last 30 years. So if the Justice Department is obstructing justice, there isn't much one can do. But I discovered a particular statute—I may be the only one that ever used this—and the wording is very clear.

"This is Title 18, Section 4," continued Stich. "It states that 'Anyone who knows of a federal crime who does not promptly report it to a federal judge or other federal officer becomes guilty of the crime of subornation of a crime'."

"So I thought this is an excellent way to circumvent the obstruction of

justice by the US Justice Department. I filed action demanding that the judge receive my evidence and the evidence of some of the other agents I had become acquainted with. By law they're required to do so. Instead, they refused to receive it."

So then what happened?

"Sometimes they dismissed it without a hearing," said Stich, "and never even allowed me to get to that point. Then they also rendered an order, and this was repeated several times, forever barring me access to the federal courts. This is, of course, unlawful and unconstitutional. And also it's obstructing justice.

"As my knowledge of criminal activities in government increased—when I started getting heavy evidence of CIA drug trafficking—I filed actions again, even though federal judges barred me access to the federal court, which they legally can't do but they do it. Then they held me in contempt of court for even trying to report the criminal activity that I must report."

Because he had been betrayed by attorneys many times before, Stich represented himself, having learned the details of navigating in the corrupt waters of the US judicial system. There were lots of shoals, and his own shipwreck was his eventual imprisonment.

"As attorneys would tell me over the years," Stich said laughingly, "If I represent you, that would be the end of my career,' because the government is very powerful and government can very easily affect an attorney's career.

"The initial imprisonment was six months in federal prison for contempt of court," continued Stich. "In other words, here I am trying to report crime that the Justice Department and federal judges were actually involved in covering up. Incidentally, to do this the federal judges had to have the cooperation of the Justice Department because the Justice Department would then file the charges and prosecute."

Is it really possible that they worked hand-in-glove to cover up

**"Tatum said that Barr then dialed another number, immediately reaching then-Governor Bill Clinton."**

the exposure of these criminal activities?

"Yes," said Stich, "and it's interesting to note that in the early stages, in one of my earlier books—the second edition of *Unfriendly Skies*—I was naming federal judges and Justice Department personnel who were blocking the reports I had of the criminal activities related to a series of air disasters. Of course, later on when I'm going to federal court with other offences, these same groups are now charging me with contempt of court for trying to expose criminal activities in which they are implicated."

"And justice for all"—from the American Pledge of Allegiance—turns out to be nothing but a sick joke.

## EVIDENCE OF CIA AND DEA DRUG TRAFFICKING

In his introduction to *Defrauding America*, Stich writes: "This book reveals criminal and subversive activities implicating high-level personnel in the three branches of the federal government. It reveals why most of the public is dangerously uninformed about the criminal acts perpetrated against the United States and its people by the very people entrusted to prevent such happenings.

"Many criminal activities, such as CIA drugging of America, will be difficult to believe by most Americans who have been shielded from the truth by a duplicitous Congress and much of the media," he continues. "For those of us who have seen these events as insiders, including those who actually participated in them, questioning whether the CIA would engage in drug trafficking is like asking pilots, 'Will planes really fly?' Yes, planes actually fly, and, yes, the CIA has been smuggling drugs into the United States for the past 50 years."

One of the most explosive chapters in the book is entitled "CIA and DEA Drug Trafficking". This includes first-hand accounts of former CIA and DEA (Drug Enforcement Administration) agents who were part of these operations.

Stich writes: "My phone was used for hundreds of hours of three-way conference calls between CIA and DEA personnel, their wives, a Mossad agent and even Ross Perot. Often the conversations were of the nature of one pilot describing to another events that they experienced, each one knowing that any fabrication would be recognized by the other. My position was like a secret mole inside covert CIA activities, adding to the discoveries I made while a federal investigator and while being victimized in one of the many criminal enterprises."

Cross-corroboration of testimony by CIA operatives Gunther Russbacher and Trenton Parker, for instance, indicates that the Colombian drug cartels were actually organised by the CIA.

"Parker told how the CIA set up the meetings in which various Colombian drug dealers organized into a drug trafficking cartel..." writes Stich. "He stated that the first meeting occurred with 20 of the biggest cocaine dealers in Colombia present; that the second and final meeting was held at the Hotel International in Medellín, attended by about 200 drug dealers... The Medellín Cartel was established in December 1981, and each of their members paid an initial US\$35,000 fee to fund a security force for the cartel mem-

bers to protect their drug operations."

Furthermore, Stich writes that CIA operative Gunther Russbacher "confirmed the meetings that Parker mentioned and that there had been a preliminary meeting in September 1981 in Buenaventura, Colombia, which established the format for subsequent meetings. Russbacher attended the September 1981 meeting which was initiated by the CIA to facilitate drug trafficking into the United States, permitting the CIA to deal with a group rather than many independent drug dealers."

What does that mean? The phony, so-called "war on drugs" is simply an operation to eliminate any competition to state-sanctioned drug trafficking.

"The average American is unaware of the gravity of the CIA's criminal activities, thanks to the orchestrated cover-up and disinformation by the establishment media," writes Stich. "The corrupt mindset has existed for years. Initiating wars as in Vietnam and assassination activities as in Vietnam and Central America are routine..."

"Although the CIA is not permitted by law to operate within the United States, it has done so. It has engaged and is engaging in many forms of criminal activities against the American people. Through fronts, cut-outs and proprietaries, the CIA has defrauded all types of US financial institutions including savings and loans, banks and insurance companies. The CIA is a major player in the looting of Chapter 11 assets, making the exercise of Chapter 11 statutory protections a trap for unwary Americans."

According to Stich's informants who are former DEA whistleblowers, the US federal agency created to stem the influx of drugs into the United States has become so corrupt that it has become an *ipso facto* drug cartel itself. These are serious criminal activities which have never been investigated or dealt with by the US Department of Justice.

"On April 4, 1993, I received the first of a series of phone calls from a former DEA pilot, Basil Abbott, who had flown drugs from Central and South America for the DEA in DEA aircraft since 1973," writes Stich in his book.

"Abbott was in federal prison, being charged with a parole violation while on a trip from Austin, Texas, to Missouri. The parole violation consisted of failure to convince the DEA agents that he was not doing anything to violate his parole. The actual reason for his arrest was that Abbott tried to interest the media and the networks in his charges that the DEA routinely engages in drug trafficking into the United States... Abbott named other DEA pilots who, acting under DEA orders, flew drug-laden aircraft from Central America to the United States. These included Floyd Carlton, Cesar Rodriguez, Daniel Miranda and George Phillips, among others..."

The intensity of the drug trafficking flights was revealed by Abbott as he described the large number of aircraft arriving and departing: "It was like Grand Central Station at some airstrips in Belize and Nicaragua."

Stich continues: "These flights were profitable for everyone involved, including the pilots." In addition to their government

**"For those of us who have seen these events as insiders, including those who actually participated in them, questioning whether the CIA would engage in drug trafficking is like asking pilots, 'Will planes really fly?'"**

salary, DEA pilots received additional money or perks. "Abbott received \$60,000 and 50 pounds of pot for this one week of flying to the Miskito Indians..."

"Abbott told me about a flight to Panama with DEA agent George Phillips [Phillips was a CIA contract agent assigned to the DEA]. While stopped for fuel at Belize, Phillips opened an aluminum suitcase that held rolls of tapes and disks marked 'Inslaw'. Phillips told Abbott that the tapes were money records of a fake company used by a group of drug dealers. This software, called 'PROMIS', was initially stolen from the Inslaw company by Justice Department officials who then sold the computer program to foreign governments and drug cartels..."

"Abbott described his frequent contacts with the DEA's Central America Bureau Chief, Sante Bario, and how the DEA silenced Bario to keep the CIA and DEA drug smuggling operations from the public... DEA and Justice Department attorneys charged Bario with federal drug offenses, causing his imprisonment... When brought before US District Judge Shannon in San Antonio, Bario tried to describe his DEA duties and the DEA and CIA drug trafficking, but Justice Department attorneys and the judge blocked him from proceeding. After being returned to his jail cell, a prison guard gave Bario a strychnine-laced peanut butter sandwich, causing immediate painful convulsions and subsequent death. The official autopsy report covered up for this murder, reporting that Bario died of asphyxiation."

#### UNINDICTED CRIMINALS IN HIGH PLACES

Stich names lots of big names in his book: public officials and well-known politicians, participants in serious criminal offences. These of course include celebrity-status politicians like the heretofore unindicted Bill Clinton, George Bush, William Barr and Oliver North.

It makes you wonder whether Stich has ever been sued or threatened by anyone for libellous content or for anything in his books that was untrue.

"No, I never have," said Stich. "Something interesting did happen a few months ago. There was one drug enforcement agent, Michael Hurley, who was agent in charge at Mena, Arkansas."

Mena, by the way, was the site of a small rural airport in Arkansas, the staging area for drug shipments into the United States during the late 1980s.

"His name originally came up in the Inslaw matter," continued Stich. "Michael Riconosciuto was involved in altering the Inslaw software which was stolen by the Justice Department people from the Inslaw company. So when Congress wanted Riconosciuto to testify to these matters, he was called by a Justice Department official and told: 'If you testify, we'll get you.' He goes and testifies, and, a week later, Michael Hurley who was a DEA agent in Nicosia was transferred to the state of Washington and was then involved in filing what I feel are false drug charges against him."

So Hurley was the one who initially set up Riconosciuto?

"Hurley was chief agent for the DEA in Mena and was well aware of the smuggling in early 1980s."

And this is the crossroads where different crimes and cover-ups intersect—what the late journalist Danny Casolaro called "the Octopus", a global cabal of dirty tricksters involved in deals around the world. According to Casolaro, the Octopus was a loosely knit international network of former CIA operatives, military men, organised crime figures and other "Beltway bandits" (former government officials) who worked together on various projects including arms manufacturing, money laundering, procurement fraud and kickbacks.

"Meanwhile," Stich added, "Lester Coleman, author of *The*

*Trail of the Octopus*, was working out of Beirut and Nicosia as an agent for the Defense Intelligence Agency [DIA]. He was instructed to spy on the DEA while he was working under the cover of the Christian Broadcast Network."

And why didn't the DIA trust the DEA?

"My understanding is that DIA felt that the DEA was heavily involved in drug trafficking," said Stich. "They just wanted to know what was going on. Coleman was an operative in Nicosia. The DIA was using [Pat Robertson's] Christian Broadcast Network as a cover. While Coleman is working in Nicosia, he finds out that Michael Hurley and the DEA are involved in a drug pipeline that involves the CIA, the DEA, the Syrian drug traffickers and Lebanese drug traffickers, and that they were using Pan Am aircraft for smuggling the drugs. It was this drug pipeline—the way it was being operated—that permitted the terrorists to put the bomb on board Pan Am 103. This is where Michael Hurley comes in. Coleman says that the DEA and Hurley were aware of and were involved in this drug pipeline."

"Michael Hurley sent me a fax four months ago," Stich added. "He said that he heard me referring to him on the Internet and he would sue me if it were untrue. So I faxed him back and said: 'Frankly, I haven't mentioned you at all on the Internet. However, since we're in contact, I want you to confirm to me that you were the DEA agent in Arkansas in the early '80s.' He never answered. But I talked with Lester Coleman, and he confirmed that, yes, it was true."

Just another unindicted criminal?

"As far as unindicted criminals are concerned," Stich noted, "you'd have a good part of the US Justice Department. But who's going to prosecute?"

#### INSTITUTIONAL CORRUPTION

So what's Stich's sense of this institutional corruption which has gone on through several administrations for at least 30 years?

"As far as Justice Department corruption is concerned, I was able to document it for the last 30 years while I was a federal investigator," replied Stich. "In fact, while I was a federal investigator with the FAA in the 1960s, I even accused, in writing, J. Edgar Hoover of criminal cover-up and obstruction of justice. You know, a federal employee can not get away with that. And there's some particular federal directive that makes that a very serious offence if you do that [accuse a public official] without having evidence. Now I had plenty of evidence. It was about 1965. I had been in contact with him for some time, bringing to his attention the criminal activities that I'd discovered in the FAA and also while I was acting as an independent prosecutor."

"I was able to document other criminal activities, not only in the FAA-related series of air disasters. I was so incensed by what was going on and the constant accidents. Every six months there would be another fatal crash. So what I did was I forced a four-month hearing upon the FAA, during which I acted as an independent prosecutor. During this time I conducted the hearing and brought testimony and hard evidence into a 4,000-page transcript. During this hearing I had FAA management engaging in perjury, subornation of perjury and fraud that I was able to document."

"People don't realise the significance of this, which I describe in *Unfriendly Skies*. This has never happened in the FAA, and probably never will again, where a key FAA investigator forces a hearing on the FAA, during which it is turned into an adversary hearing. I'm getting witnesses to testify and I'm introducing documents and there are some really unusual events going on. Plus,

Continued on page 85







# THE HEALTH DANGERS OF DAIRY PRODUCTS

*The dairy industry and food authorities know that cow's milk products cause a range of health problems, but continue to promote them as being essential to our diets.*

Edited from the Internet home page of  
**Robert "NOTMILKMAN" Cohen**  
325 Sylvan Avenue  
Englewood Cliffs, NJ 07632, USA  
Telephone: (201) 599 0325  
Toll-free in USA: 1888-NOT-MILK  
Fax: (201) 599 0338  
Website: <http://www.notmilk.com>

**W**e've been concerned for some time about the health dangers from consuming milk and dairy products. Last issue we ran an item in *Global News* on the cancer risks from BST-treated milk, and also reviewed Robert Cohen's book, *Milk: The Deadly Poison*. For this issue, we've edited a selection of questions and comments from Robert "NOTMILKMAN" Cohen's Q&A website. But be warned: after reading this, you may never drink milk again! — Editor

#### Letter 85: David Weber, Oklahoma

I became diabetic at age twenty-five. The diabetes literature makes some references to a possible link between cow's milk and diabetes. But, of course, doctors are into treating diseases and are not interested in food. If you would do clinical testing to prove that cow's milk is the cause of diabetes, and stop the spread of diabetes, you would receive the Nobel prize...

#### The NOTMILKMAN's comments:

A study at the University of Helsinki (Virtanen and Aro, "Dietary factors in the aetiology of diabetes", *Ann. Med.* 26(6):469-478, Dec. 1994) revealed that early introduction of cow's milk in babies three months of age or younger often resulted in complete insulin deficiency. This pathology occurred because naturally occurring beta cells were destroyed by the infant's allergic reaction created in response to the presence of cow's milk proteins.

Scientists in Italy noted similar effects after analysing data from diabetic children. Their conclusion indicated an absolute cause and effect relationship between milk consumption and diabetes (Fava, et al., "Relationship between dairy product consumption and the incidence of IDDM in childhood in Italy", *Diabetes Care* 17(12):1488-90, Dec. 1994).

Researchers at the University of Colorado published a paper in the *Journal of Endocrinological Investigations* which identified a bovine albumin peptide as a trigger of insulin-dependent diabetes mellitus (Norris and Pietropaolo, *J. Endocrin. Invest.* 17(7):1488-1490, July-Aug. 1994).

Early exposure to cow's milk was linked to the development of diabetes in a carefully controlled rat experiment by scientists in Canada. They linked early exposure to bovine proteins in both rodents and humans as the cause of diabetes mellitus. Their work was published in the February 1994 issue of the *Journal of Immunology*.

These above studies are examples of research that the dairy industry prefers you *not* read. The more knowledge you gain, the less ignorant you become. Ignorance is *not* bliss. Ignorance can be damned unhealthy! Armed with such facts, would you expose your infant to cow's milk? After recognising the fact that bovine proteins cause the body to react by producing antibodies which destroy insulin-producing beta cells, do you think that it is wise to drink body fluids containing hormones from another species of creature? The hormones work. If you choose to believe FDA (the US Food and Drug Administration), who assures us that the hormones in milk do not work, you play with a powerful, loaded gun. If you elect to review the scientific evidence, then you arm yourself with ammunition which will protect you.

Regards, the NOTMILKMAN

#### Letter 115: Roy Cestensen, Norway, 16 January 1998

I was quite impressed with this page, and although I've heard some of the arguments before, and therefore been sceptical of milk for many years, many were new to me. The

evidence for the dangers of milk have hardly ever been commented on in Norway.

As you may know, Scandinavians are among the most heavy milk-drinkers in the world, and the region also happens to have some of the highest rates of diabetes and osteoporosis. For instance, a news report a few days ago commented on the severe difference in the occurrence rates of diabetes between the eastern and western parts of Norway's capital, Oslo. It appears that diabetes is almost non-existent on the eastern side, which is the poorer and mostly inhabited by immigrants. Scientists pointed out a correlation in their data between the rate of infections at early age as a possible explanation. Supposedly many infections as a child may protect against diabetes later!

I don't know if there is any medical reasoning behind this, but I suspect that they haven't even considered the well-known fact that average Norwegians drink 10 times more milk than average immigrants.

**The NOTMILKMAN's comments:**

For your interest, I had a discussion with a French nutritionist yesterday. She claimed that the French eat a lot of cheese and drink a lot of milk and are still the healthiest people in the world. Well, I told her that in 1994, 16.49 American women out of 100,000 died from breast cancer. In the same year, that number was greater for France. The French eat more cheese and drink more milk than Americans, and 17.79 women out of 100,000 died from breast cancer.

Now for the really bad news. The people of Norway drink more milk than even the people of France. Ready for the breast cancer rate? It's 17.88 women per 100,000! It could be worse. The Netherlands has a rate of 22.13 breast cancer deaths per 100,000. Let's remember that Dutch milkmaid (may she rest in peace) as we learn the truth about the hormones in milk.

Regards, the NOTMILKMAN

**Letter 160: Paul M. Fleiss, MD, MPH, 21 February 1998**

Pasteurisation and homogenisation alter the composition, digestion and bioavailability of milk in a significant manner. I suggest that you look at Raw Certified Milk as produced by Steve's Natural Dairy in California for a much different product than what you are talking about. All milk is not the same!

**The NOTMILKMAN's comments:**

Dear Doctor: Many people are not aware that milk is often pasteurised two or three times before it begins to snap, crackle and pop in their cereal. Why would processors have to repeat the procedure if it works so well? Answer? Allow me to reveal what should be self-evident: pasteurisation does not work! When conditions such as heat treatment are not favourable to the little guys (Bacillus, Clostridium, etc.), they protect themselves and form

spores which then protect them from boiling and antibiotics and germicides. When the milk cools and conditions become suitable for growth, these bacteria are restored to their original state.

Most consumers are fooled by dairy industry propaganda and trust their health to the pasteurisation myth. These same consumers should use their sense of smell after even one week of refrigeration. Something's rotten in that container. The offensive smells are the toxins secreted into the milk by the cultures of micro-organ-

isms which continue to grow.

If milk is to be safe to use, it must come from clean and disease-free animals. Unfortunately, most of the milk of America contains leukaemia, tuberculosis or the bovine immunodeficiency virus, according to Virgil Hulse, MD. Dr Hulse has been a dairy inspector and is one of the well-established experts in America on this subject.

My interest in milk began about four years ago. I did not want my children overdosing on powerful growth hormones which are not destroyed by pasteurisation. I have since learned that pasteurisation does not destroy many other dangerous substances. Please look up "paratuberculosis". Cows are getting an intestinal disorder from paratuberculosis, a heat-resistant Mycobacterium. Cows get Johne's disease from this organism and humans catch this intestinal disorder by drinking the cow's milk. There is a positive link between human Crohn's disease and milk consumption.

Regards, the NOTMILKMAN

**Letter 161: Diane Parker, San Diego, 22 February 1998**

I became a vegetarian over 20 years ago and overindulged on dairy products due to my misconception about adequate protein intake. I became overweight, developed tendonitis (calcium deposits) in my elbow, and had chronic upper respiratory problems. I finally eliminated all dairy products from my diet after reading books by John

**Most consumers are fooled by dairy industry propaganda and trust their health to the pasteurisation myth.**

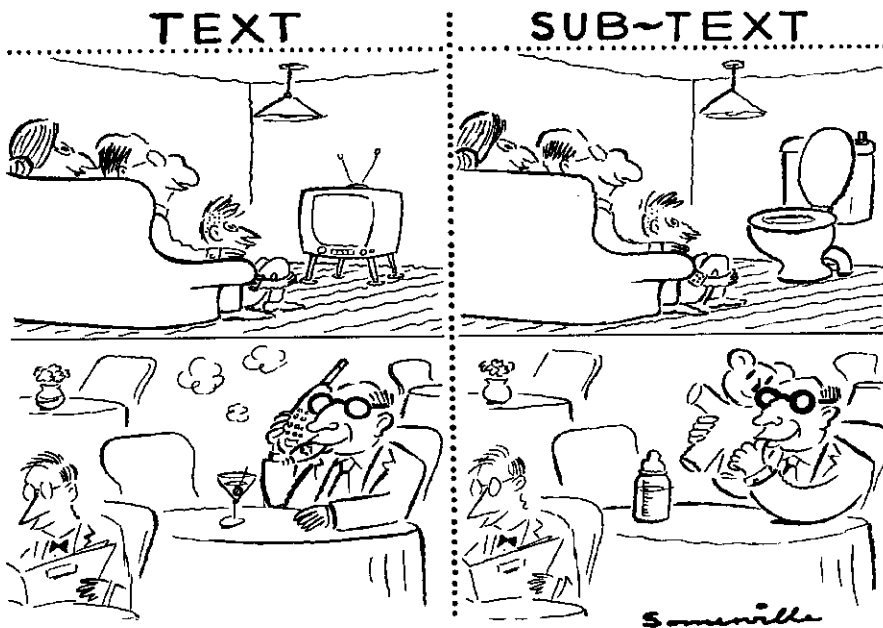

McDougall, Frank Oski, Gary Null and Neal Barnard. All of the above-mentioned health problems cleared up and my energy levels increased.

It was 10 years later that I gradually reintroduced dairy products into my diet (I still couldn't bring myself to drink straight milk). In a little over a year, my weight is out of control, excess mucus and upper respiratory problems are back with a vengeance, and I'm beginning to have joint and arthritis-like pains. I directly attribute this to my dairy product consumption.

Your site has reaffirmed my conviction to live dairy-free. I look forward to reading your book and I'm grateful to you and others who are trying to re-educate all of us.

**Letter 167: Lauri Bartlema, Texas, 27 February 1998**

I was fine until I read the "pus" part. Is it just as bad if you drink skim milk?

**The NOTMILKMAN's comments:**

Dear Lauri: Skim milk is worse! Americans have changed their diets. In 1979 the average person drank 149 pounds of whole milk and 78 pounds of low-fat milk. By 1994 the numbers were nearly reversed: 75 pounds of whole milk, 124 pounds of low-fat. We drink, on average, three ounces per day more of low-fat milk. Take the fat out of milk and you have a higher proportion of protein. Proteins in milk, particularly casein, are what cause most of the allergies which I have written about in my book, *Milk: The Deadly Poison*.

A column in the *US News & World Report* (Jan. 12, 1997, p. 22) revealed that asthma deaths have more than doubled from 1979 to 1994. The National Lung Association is at a complete loss to explain why. They conclude that there is no dietary factor. Time for a wake-up call, don't you think? If you drink Elmer's glue (casein), wouldn't you expect those bronchioles in your lungs to close up? The horror of an asthma attack: the victim gasps for breath but the glue in the lungs brings on a terrible death. For 2,598 Americans in 1979 and for 5,487 Americans in 1994, milk was a deadly poison. The *US News & World Report* article revealed that most sufferers were African Americans. They blamed asthma on poverty. What a lack of wisdom! Ninety per cent of African Americans are lactose-intolerant. These people cannot digest bovine proteins. Solution? Hire African Americans like Spike Lee, Patrick Ewing and Naomi Campbell to wear those "milkstaches". Pay 'em each to betray their own race.

Regards, the NOTMILKMAN

**Letter 175: Michael Stanley, New Jersey, 2 March 1998**

Heard you on WFAN NY this morning. What a way to wake up on a Sunday morning! You definitely got our attention. I must admit, though, that it is a hard way for us to look at the product.

My wife's first husband's family operated a dairy farm for years. I grew up down the street from a dairy farm. I spent many days there growing up. I remember many glasses of fresh milk.

Is the way that milk is produced now that much different than from a generation ago?

**The NOTMILKMAN's comments:**

Dear Michael: A generation ago, the average dairy cow yielded just eight quarts of milk per day. Today, a typical cow yields 50 quarts per day.

A generation ago, cows ate grass. Today, cows are fed bone meal and blood meal from their brothers and sisters.

A generation ago, the cream rose to the top of the glass bottle. Today the milk is homogenised, the fat molecules are made smaller and become carrier mechanisms for protein hormones which survive digestion and bypass the gut. Milk, once put into glass bottles, is now put into plastic containers.

A generation ago, farmers were allowed to put one part per hundred-million of antibiotics in milk. Today, farmers can put 100 times that level of antibiotics in milk.

A generation ago, there were few antibiotics, *ergo* few antibiotic residues in milk. Today, there are 52 different residues of antibiotics found in milk.

A generation ago, it was against the law to approve a drug for our food supply that caused cancer in laboratory animals. Today, thanks to Monsanto's attorney (Mike Taylor) hired by FDA, the law prohibiting cancer in lab animals has been changed, minimising the way FDA now looks at cancer.

A generation ago, one out of 20 women was expected to get breast cancer. Today, according to an article in the *New York Times* (Nov. 8, 1994), 39 per cent of American women between the ages of 40 and 50 have cancer in their breasts.

A generation ago, it was rare to hear of a child getting cancer or leukaemia or needing a bone marrow transplant. Today, this all breaks my heart.

Regards, the NOTMILKMAN

**Letter 269: Paul Gadebusch III, 5 April 1998**

Interesting. The conclusions leave out some steps, but worthy of consideration.

The fact that 60 per cent of cows have the leukaemia virus—do humans catch leukaemia from bovine leukaemia virus? Is it in the milk? I am willing to buy a lot of what you say.

**The NOTMILKMAN's comments:**

Dear Paul: Herds having 80 per cent or more cows infected with leukaemia are not uncommon. Dairy industry expert Virgil Hulse, MD, recently testified in pre-trial depositions for Oprah Winfrey that 60 per cent of the cows are infected with bovine leukaemia virus. Hulse details how leukaemia crosses the species barrier in his brilliant book, *Mad Cows and Milk Gate*. You can buy the book from Marble Mountain Publishing at (541) 482 2048. Hulse identifies leukaemia clusters among school children and dairy workers, which he traces back to infected herds.

I have devoted a chapter of my book, *Milk: The Deadly Poison*, to leukaemia. Lab animals treated with the hormones found in America's milk had an average spleen increase of 46 per cent after just 90 days. The same-size spleen increase in humans would

**A generation ago, cows ate grass. Today, cows are fed bone meal and blood meal from their brothers and sisters.**

**A generation ago, farmers were allowed to put one part per hundred-million of antibiotics in milk. Today, farmers can put 100 times that level of antibiotics in milk.**

often result in a leukaemia diagnosis. I know very little about the cure, but I do know a lot about the prevention: NOT MILK!

Regards, the NOTMILKMAN

**Letter 277: Marcy, Connecticut, 8 April 1998**

Dear Robert: I'd like to share information with you on my son who has been diagnosed with mild autism. Although he was born perfectly healthy and developed normally, he was given a contaminated oral polio vaccine with the DPT at 18 months, which caused autism and sent his immune system into an activated state, causing numerous allergies. At the time, his diet consisted mainly of dairy products which he craved, and as it was increased he became more and more 'classically' autistic. He was lost in his own world, appeared deaf, and was unaware of people or things around him.

My husband and I began seeing an expert in autism in Weston, CT, who told us that autistic children are unable to digest milk and gluten properly: the peptides become toxic to the system and cause brain damage. Once my son was off dairy, he came back to the real world and lost many autistic symptoms. He still has language delays and sensory issues, but he is very sweet and interactive, and close to being a normal child.

On the other hand, my daughter, who is three, was taken off dairy at five months when we wised up to the dangers of milk. She is gifted and extraordinary, and people are amazed by her. My husband and I truly believe that this is due to the lack of milk in her diet. And both children love their rice milk, by the way!

Another thing is, I see issues in all the children I know who have dairy-based diets: either ADD, sensory difficulties, erratic behaviour, developmental delays, or poor health. Unfortunately it is very difficult to convince other mothers that it would be in their child's best interest to eliminate or even cut back on dairy.

Thank you for, and good luck with, your incredibly important research!

**Letter 289: Brandi, Kentucky, 10 April 1998**

I am responding to your reply to my comment on April 8. I am going to be civil with this. I've read those comments from others who curse you and call you every name in the book. That gets them nowhere. Let me begin with the antibiotics.

I can't speak for every Tom, Dick and Harry Dairyman out there, but let me tell you this, Mr Cohen: there are no antibiotic residues in our milk. We throw the milk away from a treated cow. There may be those out there who know nothing of the milking process. We individually test each cow's milk, if she has been treated with antibiotics, before we even think of putting her milk into the bulk tank. Then, on top of that, the milk truck driver pulls a sample from our tank, then pumps the milk from our tank onto his truck. He takes all those samples from each dairy and the laboratory runs tests on them. If my sample was somehow to show up as laced with antibiotics, the entire truckload of milk is driven back to my farm and dumped into our manure pit. We end up paying for the entire load.

I've seen those TV shows where a carton of milk from the grocery was tested and showed antibiotics. I don't know how that happened. Why would a dairy farmer knowingly allow milk laced with antibiotics to flow into his bulk tank cooler? If anyone does that, then they must be pretty courageous and a little insane.

**The NOTMILKMAN's comments:**

Dear Brandi: I believe you and respect the fact that your milk does not contain antibiotics. I also respect *Consumers Reports* magazine and the *Wall Street Journal*. Both independently tested milk in the New York metropolitan area and found 52 different antibiotic residues. Your milk is mixed with the milk from your neighbours' farms.

Something terrible happened in 1989. Monsanto began to test their new genetically engineered hormone on dairy herds and found that the tested cows were getting ulcers on their udders. Milk from these sick cows contained more pus and bacteria.

Monsanto's solution was to send their top dairy scientist, Margaret Miller, PhD, to work at the FDA.

When a farmer has a sick cow he must treat her with antibiotics. For every sick cow with visible ulcers (mastitis), there are anywhere from 15 to 40 animals that also have internal ulcers not visible upon inspection. In a 1,000-cow herd, that means that if 10 cows were visibly sick there could be between 150 to 400 additional sick animals. The dairy farmer's solution was to treat the entire herd with drugs.

Monsanto's Miller was hired by FDA. Her first mission was to solve this problem. Her solution was simple: she increased the safe allowable levels of antibiotics permitted in milk from one part per hundred-million to one part per million (ppm)! Because of Monsanto's dairy scientist-turned-FDA bureaucrat, farmers were allowed to increase antibiotics in milk by 100 times. Most milk is accepted because the limits were increased by 100 times!

In the meantime, the Centers for Disease Control and every mother with a sick child know that antibiotics no longer work. New strains of emerging diseases have developed immunities to these antibiotics. America overdoses on these wonder drugs every single day. Your milk and dairy products represent 39 per cent of what the average American eats.

age American eats.

On March 16, 1994, a letter signed "Concerned CVM [Center for Veterinary Medicine] Employees" was circulated to members of Congress, GAO, FDA Commissioner David Kessler, the Inspector-General of the United States Richard Kusserow, and Michael Hansen of Consumers Union.

Here is part of the chilling letter. The entire letter can be found in my book, *Milk: The Deadly Poison*, along with supporting documents.

"To whom it may concern:

"We are a group of CVM/FDA employees who are very concerned about the FDA's recent decision not to label milk treated with BST [bovine somatotropin]. We are afraid to speak openly about the situation because of retribution from our director, Dr

**Consumers Reports  
magazine and the Wall  
Street Journal...  
independently tested  
milk in the New York  
metropolitan area and  
found 52 different  
antibiotic residues.**

Robert Livingston. Dr Livingston openly harasses anyone who states an opinion in opposition to his.

"The basis of our concern is that Dr Margaret Miller, Dr Livingston's assistant and, from all indications, extremely 'close friend', wrote the FDA's opinion on why milk from BST-treated cows should not be labeled. However, before coming to FDA, Dr Margaret Miller was working for the Monsanto company as a researcher on BST. At the time she wrote the FDA opinion on labeling, she was still publishing papers with Monsanto scientists on BST. It appears to us that this is a direct conflict of interest to have in any way Dr Miller working on BST. As you know, if milk is labeled as being from BST-treated cows, consumers will not buy it and Monsanto stands to lose a great deal of money. Several of Dr Miller's former colleagues would lose their jobs.

"To add to this, Dr Livingston had Dr Miller write a policy on use of antimicrobials in milk. She picked an arbitrary and unscientifically unsupported number of 1 ppm as being the allowable amount of antimicrobial in milk permitted without any consumer safety testing. This is for any antimicrobial. A cow could be treated with several antibiotics and each one would be permitted to be in milk at a level of 1 ppm without additional consumer safety testing. Effects of the different antibiotics could be additive and this is not taken into account.

"As you know, one big concern for BST is that it leads to increased antibiotic use..."

The truck driver tests the milk. It is well within the safe limits established by the FDA. He happily drives away, unaware that the limits were arbitrarily increased by 100 times. We drink the milk and eat the cheese, unaware that we now consume 100 times the previously safe limits. FDA continues to tell America that permissible antibiotics in milk are well within the safe limits. They omit the fact that they changed the limits. Let the truth be known!

Regards, the NOTMILKMAN

#### Letter 305: Name withheld on request, 15 April 1998

Had to respond to the dairymen who claim that testing eliminates antibiotics from milk. You may post this message, but please withhold my contact info (whistleblowing has no reward).

Farmers are not required to test for antibiotics. Only bulk tank producers test before adding milk to the huge silos. They are required to test each truckload for a tiny handful of antibiotics (the five or six target antibiotics that are deemed most used by farmers). When a farmer has his truckload rejected, what does he do? He switches antibiotics to one which is not on the list. It will be added to the list by the FDA when they feel it has become a problem.

Initially, farmers only had to screen for penicillin. Later amoxicillin, ceftiofur and others were added. The milkman is playing a constant game of hide-and-seek with your milk, and you're losing!

Now let's discuss "safe levels". These are

like radiation "acceptable doses", constantly changing as you've noted. But what you should research is the tests that are used to detect these levels. FDA requires tests to be certified that they do indeed detect these antibiotics. Recently, FDA evaluated several tests from several manufacturers. Tests were required to correctly capture tainted milk from several samples. Only one manufacturer's tests passed on the first round. So the FDA, reluctant to grant a virtual monopoly to the company, loosened the specs and allowed a second round with a few "mistakes". Some companies failed this round, too. So they loosened the specs again to allow dairy producers to use less-sensitive tests and pass more milk into the food chain. By regulation, this dose response and sensitivity info is posted on the tests' instructions. Remember, these loosened tests are only looking for the target antibiotics. Who knows what levels of non-target or even illegal antibiotics are in there?

And with hundreds of thousands of dollars at stake, milk producers are looking for any excuse to accept the milk—rather than rejecting it at the slightest hint of contamination.

Ready for another shocker? Sometimes they dump contaminated milk. Sometimes they feed it to the other cows! Then they wonder why the cows no longer respond to the drug to clean up mastitis. This info could get me fired, but you seem to be the only one willing to publicise the truth about overuse of antibiotics in the food chain. Growth hormones

will not kill us. We'll be long dead from some resistant "superbug" before the cancer sets in.

#### The NOTMILKMAN's comments:

Wow! What a letter! I know what you know, and so do the milk inspectors and so do the regulators at USDA [US Dept of Agriculture] and FDA. The secrets of the dairy industry are now being revealed to the world. Monsanto genetically engineered the bovine growth hormone and, in doing so, opened up an enormous Pandora's box that can never again be closed.

I was going to ask you whether or not you drink the milk which you produce. I think that I know the answer.

Regards, the NOTMILKMAN

**All humans drink powerful growth hormones in each sip of milk.  
All humans eat large amounts of animal fat if they drink milk.  
All humans eat dangerous cholesterol if they drink milk.**

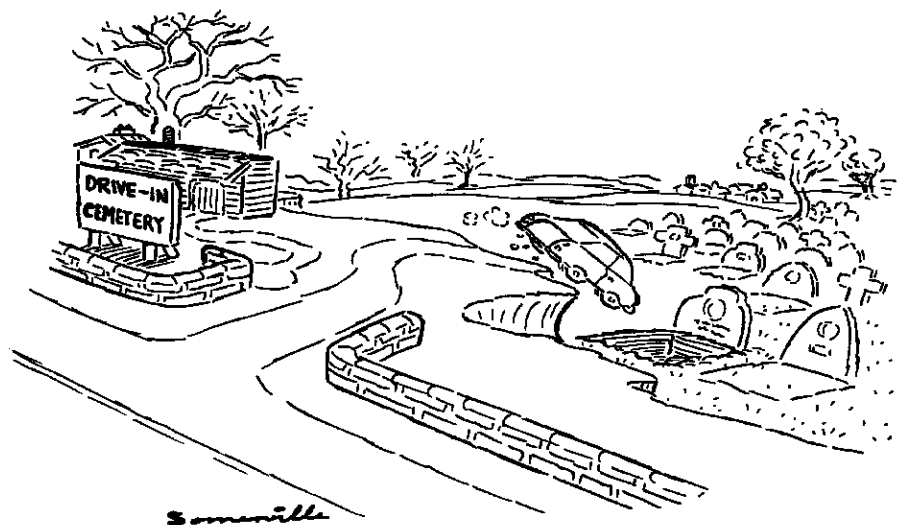

**Letter 291: Jeffree Moline, 10 April 1998**

I left a message several days ago and bounced back on to check out the site again. A really great site! I noticed that you are getting a lot of flack from the pro-dairy folks. All I can say is, if they believe that dairy is so good, then eat it. If they think dairy is so good, why do they insist on vicious diatribes to support their (in my opinion, unwinnable) position. They have huge industries and advertising agencies to support them. Why are they so scared of a small, private website?

There are many reasons I don't drink milk (one is that it causes excess mucus in my body, and less mucus is good). Yes, I will eat my greens and enjoy my ice-cold glass of rice, soy or oat milk...so good, and good for me. Thank you for having the courage to do this page and deal with the ignorant masses of consumers who aren't ready for the message.

**The NOTMILKMAN's comments:**

Dear Jeffree: I am amazed by the number of dairy farmers who have written privately to me, confessing that they no longer drink milk because it "doesn't agree" with them.

All people react negatively to milk proteins. Some of us have the ability to pay attention to the body's clues and have linked milk consumption to a variety of problems: mucus production, haemoglobin loss, childhood diabetes, heart disease, atherosclerosis, arthritis, kidney stones, mood swings, depression, irritability and allergies. This list was published in the *Townsend Letter for Doctors and Patients*.

All humans produce 100 different antibodies to bovine proteins. All humans drink powerful growth hormones in each sip of milk. All humans eat Elmer's glue if they drink milk. All humans eat large amounts of animal fat if they drink milk. All humans eat dangerous cholesterol if they drink milk. All humans eat pus if they drink milk. All humans eat bacteria if they drink milk.

Regards, the NOTMILKMAN

**Letter 380: Andrew, Massachusetts, 5 May 1998**

Please provide data, statistics or scientific evidence which prove or support this statement: "Milk is the foundation of heart disease and the explanation for America's number-one killer." I would prefer that you state the data rather than just the source, so that all might understand how you justify making such a statement. Are there studies of heart disease victims which show that milk or dairy products were a substantial factor in the cause of this disease in individuals? If so, please name and briefly summarise them, and let us all know where we might access them.

**The NOTMILKMAN's comments:**

Dear Andrew: Hundreds of studies have implicated milk and dairy products as the leading cause of heart disease. Many such studies are cited in *Milk: The Deadly Poison*.

High triglyceride and cholesterol levels are both associated with coronary heart disease. One study (*J. Clinical Biochemistry and Nutrition* 9(1):61-66, 1990) showed that adult milk drinkers (those consuming more than 200 ml daily) have higher total cholesterol levels, higher low-density lipoprotein-cholesterol ('bad' cholesterol) levels, and higher triglyceride levels than those who drink less than 60 ml per day.

Oster and Ross (two Connecticut cardiologists) found that their

heart attack patients *all* experienced the destruction of one-third of the cellular material in their atrial cells. These two men identified bovine xanthine oxidase as the cause of this cellular degradation. The key event, in their opinion, was how bovine proteins survive digestion and bypass the gut as a result of homogenisation which micronises liposomes (makes fat molecules smaller). Oster and Ross considered their 1973 discovery to be a "triumph over the most serious threat to life today". Although every one of 300 heart attack patients produced antibodies to these dangerous bovine proteins, proving that they did survive digestive processes, FDA continues to maintain the position that proteins do not survive digestion (*Proc. Soc. Exper. Bio. & Med.* 163(1), Jan. 1980).

Every health agency and medical journal has warned about the danger of consuming animal fats. The average American eats a total of three ounces of meat and chicken each day, while consuming more than 10 times that amount in milk and dairy products which contain the same dangerous animal fats. If you are the average American, from milk and dairy products (ice cream, cheese, butter, etc.) you will consume this year the same cholesterol contained in 19,000 slices of bacon.

Andrew, do you really want a study? Try and advertise for volunteers for a one-year study to test the effects of eating 53 slices of bacon each day for 365 days. Imagine your doctor giving you such advice. You would want to find a new doctor!

Take those 19,000 slices of bacon and multiply by 52 and you'll find the average 52-year-old having consumed the same cholesterol as contained in 1,000,000 slices of bacon. He and his doctor have no clue as to what causes heart disease—America's number-one killer. Neither does the American Heart

Association (AHA), which continues to endorse milk and dairy products as an important part of the American diet. Without dairy industry funding and continued heart disease, these phoneyes at AHA would be out of business. If a company donates \$60,000 to the AHA, they receive their approval and permission to advertise the heart logo on their product. I know of at least one milk company that enjoys the benefit of fooling Americans into believing that their product is healthy.

The AHA recently informed the NOTMILKMAN that they would *not* allow his book or any part of his agenda to be marketed at their convention. These prostitutes would sell the hearts and souls of Americans for the almighty dollar; yet, faced with evidence that the average American eats the same dangerous cholesterol each year from milk and dairy products that is contained in 19,000 slices of bacon, they *heartily* endorse such practice.

Regards, the NOTMILKMAN

**About the Commentator**

Robert "NOTMILKMAN" Cohen studied physiological psychology at Long Island University's Southampton College but did not pursue his career in biological research. Twenty-four years later, out of concern for the welfare of his school-age children, he decided to investigate the scientific data on the controversial genetically engineered bovine growth hormone developed by Monsanto and approved by the FDA without human trials. Cohen's book, *Milk: The Deadly Poison*, is the result of three years of intensive research into the adverse health effects of dairy products and milk hormones and the dubious practices of food/health authorities and industries. (Copies of the book can be obtained from the publisher, Argus Publishing, Inc., 301 Sylvan Ave, Englewood Cliffs, NJ 07632, USA, phone (201) 871 5871, fax (201) 871 9304.)

**Hundreds of studies have implicated milk and dairy products as the leading cause of heart disease.**







# Shaken Baby Syndrome

## – THE VACCINATION LINK –

*Many infants who suffer the so-called 'shaken baby syndrome' may be victims of undiagnosed vaccine damage.*

by Viera Scheibner, PhD © 1998

178 Govetts Leap Road  
Blackheath, NSW 2785  
Australia  
Telephone: +61 (0)2 4787 8203  
Fax: +61 (0)2 4787 8988

Recently there has been quite an "epidemic" of the so-called "shaken baby syndrome". Parents, usually the fathers, or other care-givers such as nannies have increasingly been accused of shaking a baby to the point of causing permanent brain damage and death. Why? Is there an unprecedented increase in the number of people who commit infanticide or have an ambition to seriously hurt babies? Or is there something more sinister at play?

Some time ago I started getting requests from lawyers or the accused parents themselves for expert reports. A close study of the history of these cases revealed something distinctly sinister: in every single case, the symptoms appeared shortly after the baby's vaccinations.

While investigating the personal medical history of these babies based on the care-givers' diaries and medical records, I quickly established that these babies were given one or more of the series of so-called routine shots—hepatitis B, DPT (diphtheria, pertussis, tetanus), polio and HiB (*Haemophilus influenzae* type B)—shortly before they developed symptoms of illness resulting in serious brain damage or death.

The usual scenario is that a baby is born and does well initially. At the usual age of about two months it is administered the first series of vaccines as above. (Sometimes a hepatitis B injection is given shortly after birth while the mother and child are still in hospital. However, a great number of babies now die within days or within two to four weeks of birth after hepatitis B vaccination, as documented by the records of the VAERS [Vaccine Adverse Event Reporting System] in the USA.) So, the baby stops progressing, starts deteriorating, and usually develops signs of respiratory tract infection. Then comes the second and third injections, and tragedy strikes: the child may cry intensely and inconsolably, may stop feeding properly, vomit, have difficulty swallowing, become irritable, stop sleeping, and may develop convulsions with accelerating progressive deterioration of its condition and mainly its brain function.

This deterioration may be fast, or may slowly inch in until the parents notice that something is very wrong with their child and then rush it to the doctor or hospital. Interestingly, they are invariably asked when the baby was immunised. On learning that the baby was indeed "immunised", the parents may be reassured that its symptoms will all clear up. They are sent home with the advice, "Give your baby Panadol". If they persist in considering the baby's reaction serious, they may be labelled as anxious parents or trouble-makers. So the parents go home, and the child remains in a serious condition or dies.

Until recently, the vaccine death would have just been labelled "sudden infant death", particularly if the symptoms and pathological findings were minimal. However, nowadays, with an alarmingly increasing frequency, the parents (or at least one of them, usually the father) may be accused of shaking the baby to death. The accused may even "confess" to shaking the baby, giving the reason, for example, that having found the baby lying still and not breathing and/or with a glazed look in its eyes, they shook it gently—as is only natural—in their attempt to revive it. Sometimes, ironically, they save the baby's life, only to be accused of causing the internal injuries that made the baby stop breathing in the first place, and which in fact were already present when they shook the baby to revive it.

No matter what the parents say or do, everything is construed against them. If they are crying and emotional, they will be accused of showing signs of guilt. If they manage to remain composed and unemotional, they will be called calculating and controlling—and guilty because of that.

In another scenario the distraught parents try to describe the symptoms to an attending

doctor in hospital or a surgery but are totally at a loss to understand what has happened to their baby. To their shock and dismay, they later discover that while they were describing the observed symptoms, the doctor or another staff member was writing three ominous words in the medical record: shaken baby syndrome.

Many of these parents end up indicted and even sentenced to prison for a crime that somebody else committed. Some of these cases have been resolved by acquittal on appeal or have been won based on expert reports demonstrating vaccines as the cause of the observed injuries or death. However, only God and a good lawyer can help those parents or care-givers who happen to be uneducated, or have a criminal record, particularly for violence, or have a previous history of a similar "unexplained" death of a baby in their care, or, worse still, a vaccine-injured baby with a broken arm or fractured skull. More and more often, the unfortunate parents are given the option of a "deal": if they confess and/or plead guilty, they will get only a couple of years in prison; but if they don't, they may end up getting 20 years.

I was told by a social worker in the United States that many foster parents are rotting in US prisons. First, they are forced to vaccinate their charges, and then, when side effects or death occur, they are accused of causing them.

Inevitably the possibility exists that infanticide or child abuse is involved in some of the cases. However, there is no determinable reason why so many parents or other care-givers would suddenly begin to behave like this. It is incredibly insensitive and callous to immediately suspect and accuse the distraught, innocent parents of harming their own baby.

## MEDICAL STUDIES

Let's now have a look at medical literature dealing with shaken baby syndrome and child abuse.

Caffey (1972, 1974)<sup>1,2</sup> described the "whiplash shaken infant syndrome" as a result of manual shaking by the extremities with whiplash-induced intracranial and intraocular bleedings, linked with permanent brain damage and mental retardation. He referred to his own paper, published almost 30 years prior to the above-quoted papers, which described what he called "the original six battered babies in 1945". The essential elements in this description were subdural haematomas, intraocular bleedings and multiple traction changes in the long bones. These findings became a benchmark of the "evidence" that a child had been shaken before developing these signs.

Reece (1993)<sup>3</sup> analysed fatal child abuse and sudden infant death syndrome (SIDS) and considered the critical diagnostic decisions. He emphasised that distinguishing between an unexpected infant death due to SIDS and one due to child abuse challenges paediatricians, family physicians, pathologists and child protection agencies. On the one hand, they must report instances of suspected child abuse and protect other children in the family; and on the other, all agree that the knowledge in this area is incomplete and ambiguity exists in many cases.

Duhaime et al. (1992)<sup>4</sup> wrote that "patients with intradural haemorrhage and no history of trauma must also have clinical and radiographic findings of blunt impact to the head, unexplained

long-bone fractures or other soft tissue inflicted injury, in order to completely eliminate the possibility of spontaneous intracranial haemorrhage such as might rarely occur from a vascular malformation or a bleeding disorder".

While it is not disputed that some parents and care-givers may cause the above injuries by mistreating infants, one must take great care in interpreting similar pathological findings of injuries caused by other insults which have nothing to do with mechanical injuries and mistreatments of infants.

I shall never forget the father of a 10-month-old infant, who, after being acquitted on appeal of causing shaken baby syndrome, said words to the effect, "We still don't know what killed our baby". It did not occur to them and nobody told them that it was the vaccine that killed their baby.

So what else can cause brain swelling, intracranial bleeding, ocular retinal haemorrhages, and broken skull and other bones? Ever since the mass vaccination of infants began, reports of serious brain, cardiovascular, metabolic and other injuries started filling pages of medical journals.

Indeed, vaccines like the pertussis (whooping cough) vaccine are actually used to induce encephalomyelitis (experimental allergic encephalomyelitis) in laboratory animals (Levine and Sowinski, 1973<sup>5</sup>). This is characterised by brain swelling and haemorrhaging of an extent similar to that caused by mechanical injuries (Iwasa et al., 1985<sup>6</sup>).

Munoz et al. (1981)<sup>7</sup> studied biological activities of crystalline pertussigen—a toxin produced by *Bordetella pertussis*, the causative agent in pertussis and an active ingredient in all types of pertussis vaccines whether whole-cell or acellular—in a number of laboratory experiments with mice. They established that minute amounts of pertussigen induced hypersensitivity to histamine (still detected 84 days after administration), leucocytosis, production of insulin, increased production of IgE and G1 antibodies to hen egg albumin, susceptibility to anaphylactic shock and vascular permeability of striated muscle. A dose of 546 nanograms per mouse killed 50 per cent of mice. Typically, the deaths were delayed. When a dose of five micrograms of pertussigen was administered, most mice did not gain weight and died by day five; the last mouse died on day eight. A one-microgram dose of one preparation killed four out of five mice. They first gained weight from days two to five, but then remained at nearly constant weight until they died. Even the one that survived for 16 days (it was then killed) experienced crises (stopped putting on weight) on the days when the others died. Had that one lived longer, it might have died on day 24. This is another of the critical days—identified by Cotwatch research into babies' breathing—on which babies have flare-ups of stress-induced breathing, or die, after vaccination.

Interestingly, when laboratory animals develop symptoms of vaccine damage and then die, it is never considered coincidental; but when children develop the same symptoms and/or die after the administration of the same vaccines, it is considered coincidental or caused by their parents or other carers. When all this fails, then it is considered "mysterious".

Delayed reactions are the norm rather than the exception. This has been explained as a consequence of an immunological

**...many foster parents are rotting in US prisons. First, they are forced to vaccinate their charges, and then, when side effects or death occur, they are accused of causing them.**

intravascular complexing of particulate antigen (whole-cell or acellular pertussis organisms) (Wilkins, 1988<sup>8</sup>). However, vaccinators have great difficulty with this, and as a rule draw largely irrelevant timelines for accepting the causal link between administration of vaccines and onset of reactions—usually 24 hours or up to seven days. However, most reactions to vaccines are delayed, and most cases are then considered unrelated to vaccination.

One only has to peruse a product insert of hepatitis B vaccine to see that besides local reactions, a number of neurological signs may occur, such as paraesthesia and paralysis (including Guillain-Barre syndrome, optic neuritis and multiple sclerosis).

Devin et al. (1996)<sup>9</sup> described retinal haemorrhages which are emphatically being considered the sure sign of child abuse, even though these can be and are caused by vaccines. Goetting and Sowa (1990)<sup>10</sup> described retinal haemorrhage which occurred after cardiopulmonary resuscitation in children.

Bulging fontanelle due to brain swelling was described by Jacob and Mannino (1979)<sup>11</sup> as a direct reaction to the DPT vaccine. They described a case of a seven-month-old baby who, nine hours after the third DPT vaccination, developed a bulging anterior fontanelle and became febrile and irritable.

Bruising and easy bleeding is one of the characteristic signs of the blood clotting disorder, thrombocytopenia—a recognised side-effect of many vaccines. Its first signs are easy bruising and bleeding and petechial (spotlike) rash. Thrombocytopenia may result in brain and other haemorrhages (Woerner et al., 1981<sup>12</sup>).

The convulsions which follow one in 1,750 doses of the DPT vaccines (Cody et al., 1981<sup>13</sup>) can result in unexplained falls in bigger children who can sit up or stand, which may cause linear cracks of the skull and other fractures. When one considers that babies are supposed to get a minimum of three doses of DPT and OPV (oral polio vaccine), then the risk of developing a convulsion is one in 580, and with five doses the risk rises to one in 350. This means that a great number of babies develop convulsions after vaccination between the ages of two to six months, at about 18 months, and at five to six years. The convulsions often occur when the parent or another carer is not looking, and the child, while standing or sitting on the floor, simply falls backwards or onto its arm.

All these signs can be misdiagnosed as a result of mechanical injuries, particularly so because vaccinators simply refuse to admit that vaccines cause serious injuries, or they only pay lip service to the damage caused by the pernicious routine of up to 18 vaccines with which babies are supposed to be injected within six months of birth.

The court system should therefore be more open to the documented viable and alternative explanations of the observed injuries, and be more wary of the obviously biased statements of the provaccination "experts", that nothing else but vigorous shaking can cause retinal haemorrhages—even though such statements only reflect their ignorance. Such "experts" then go home and continue advising parents to vaccinate, and thus, with impunity, they cause more and more cases of vaccine-injured babies and children.

## THE UK MEASLES EPIDEMIC THAT NEVER WAS

The term "Munchausen syndrome per proxy" has been used to identify individuals who kill or otherwise harm a child in order to attract attention to themselves. The term was used in many instances in the 1980s when earlier attempts were fashioned to explain some of the cases of sudden infant death.

According to Meadow (1995),<sup>14</sup> "Munchausen syndrome per proxy" is flamboyant terminology originally used for journalistic reasons. It was a term commonly applied to adults who presented themselves with false illness stories, just like the fictional Baron von Munchausen who travelled on cannon balls. The term is now used to apply to parents of children who present with false illness stories fabricated by a parent or someone else in that position.

While the term may have some validity in describing this special form of child abuse in the documented cases of parents slowly poisoning their child or exposing it to unnecessary and often dangerous and invasive medical treatments, more recently it

became a way for some doctors to camouflage the real observed side-effects of especially measles (M), measles-mumps-rubella (MMR) and measles-rubella (MR) vaccinations in the UK. Many thousands of British children (up to 15,000 in my considered opinion) developed signs of autism usually associated with bowel symptoms after being given the above vaccines in 1994.

The *Bulletin of Medical Ethics* published two articles, in 1994 and 1995, dealing with this problem. The October 1994 article ("Is your measles jab really necessary?") stated that during November 1994 the UK

Government would be running a mass campaign of measles vaccination with the intention of reaching every child between the ages of five and sixteen.

It claimed that the purpose of this campaign was to prevent an epidemic that would otherwise occur in 1995, with up to 200,000 cases and up to 50 deaths. The article also showed that since 1990 there have been only 8,000 to 10,000 cases of measles each year in England and Wales, and that coincidentally there was an epidemic of only about 5,000 cases in Scotland in the winter of 1993–94. Between May and August 1994 the notification rate in England and Wales dropped sharply, so there was nothing that clearly suggested an imminent epidemic.

The nine-page article in the August 1995 issue of *BME* stated among other things that on 14 September 1992 the Department of Health (DoH) hastily withdrew two brands of MMR vaccines following a leak to the national press about the risk of children developing mumps meningitis after administration of these vaccines. Both brands contained the Urabe mumps vaccine strain which had been shown to cause mumps meningitis in one in 1,044 vaccinees (Yawata, 1994<sup>15</sup>).

Based on the epidemiology of measles, there was never going to be a measles epidemic in 1995 and there was certainly no justification for concomitant rubella vaccination. The mass campaign was planned as an experimental alternative to a two-dose schedule of measles-mumps-rubella vaccination. The UK Government knowingly misled parents about the need for the campaign and about the relative risks of measles and measles vaccination. The DoH broke the European Union's law about contracts and tendering to ensure that specific pharmaceutical companies were award-

**The court system should therefore be more open to the documented viable and alternative explanations of the observed injuries, and be more wary of the obviously biased statements of the provaccination "experts"...**

ed the contracts to provide the campaign vaccines. All this must have been extremely fortunate for the drug companies in question, since the supplies of measles and rubella vaccines—which they'd been left with in 1992 and for which there was virtually no demand—were soon to go out of date.

The vaccination campaign achieved very little. Indeed, in 1995 there were twice as many cases of serologically confirmed rubella in England and Wales as in the same period of 1994: 412 cases against 217. Six cases of rubella in pregnant women were reported. The data indicate that more measles cases were notified in the first quarter of 1995 (n=11) than in the first quarter of 1994 (n=9). Despite this, there were several claims from government doctors that measles transmission had stopped among school children. Higson (1995)<sup>16</sup> wrote that two DoH officials tried to justify the success of the measles and rubella vaccination campaign by using data that cannot be used to give year-on-year comparison for measles infections. Indeed, he wrote that the data collected by the public health departments on the measles notifications show no indication of benefit from the highly expensive campaign. The British government spent some £20 million purchasing the near-expiry-date measles and rubella vaccines.

Some 1,500 parents are now participating in a class action over the damage (most often the bowel problems and autism) suffered by their children.

Wakefield et al. (1998)<sup>17</sup> published a paper in the *Lancet* in which they reported on a consecutive series of children with chronic enterocolitis and regressive developmental disorder which occurred 1 to 14 days (median, 6.3 days) after M, MMR and MR vaccinations. They also quoted the "opioid excess" theory of autism, that autistic disorders result from the incomplete breakdown and excessive absorption of gut-derived peptides from foods, including barley, rye, oats and milk/dairy product casein, caused by vaccine injury to the bowel. These peptides may exert central-opioid effects, directly or through the formation of ligands with peptidase enzymes required for the breakdown of endogenous central-nervous-system opioids, leading to disruption of normal neuroregulation and brain development by endogenous encephalins and endorphins.

A number of British parents approached me last year and complained that their children had developed behavioural and bowel problems after vaccination (as above), and that instead of getting help from their doctors they were told that they just imagined the symptoms or caused them in order to attract attention to themselves. The term "Munchausen syndrome per proxy" was used. It caused a lot of hardship and marital problems and did nothing for the victims of vaccination. Their stories were horrifying.

## EDUCATION ON VACCINE DANGERS

In summary, the trail of vaccine disasters is growing. Not only do vaccinations do nothing to improve the health of children and other recipients, they cause serious health problems and hardship for their families by victimising the victims of vaccines.

Parents of small children of vaccination age should use their own judgement and should educate themselves about the real dangers of this unscientific, useless, harmful and invasive medical procedure. No matter how much vaccines are pushed, vaccination

is not compulsory in Australia (though the Liberal Federal Minister for Health has announced his plan to make it so in the near future—which, to me, sounded more like a threat at the time), and parents do not have to vaccinate their children. Those parents who think they are safe when they follow the official propaganda may be in for a rude awakening: they may be accused of causing the harm which resulted from vaccination.

I also urge medical practitioners to use their own judgement and observations and study the trail of disaster created by vaccination. They should listen when their patients and especially the parents of small children report side effects of vaccinations.

The inability to listen and observe the truth has created a breed of medical practitioners who inflict illness rather than healing, who become accusers rather than helpers, and who are ultimately just covering up—whether consciously or unknowingly, but with frighteningly increasing frequency—for the disasters created by their useless and deadly concoctions and sanctimonious ministrations. Maybe the term "Munchausen boomerang" should be introduced to describe those members of the medical profession who victimise the victims of their own harmful interventions (vaccines in particular).

I would like to remind those who may still think the risks of vaccine injury are outweighed by the benefits from vaccines, that infectious diseases are beneficial for children by priming and maturing their immune system. These diseases also represent developmental milestones. Having measles not only results in a lifelong specific immunity to measles, but also a non-specific immunity to a host of other, more serious conditions: degenerative diseases of bone and cartilage, certain tumours, skin diseases and immunoreactive diseases (Ronne, 1985<sup>18</sup>). Having mumps has been found to protect against ovarian cancer (West, 1966<sup>19</sup>). So there is no need to try to prevent children from

getting infectious diseases.

Moreover, according to orthodox immunological research, vaccines do not immunise, they sensitise; they make the recipients more susceptible to diseases (Craighead, 1975<sup>20</sup>). It is the vaccinated children who suffer chronic ill health (asthma and constant ear infections being two of many vaccine side effects); who develop side effects to diseases like pneumonia or atypical measles (which carries a 12 to 15 per cent mortality risk); or who may have difficulty going through even such innocuous diseases as chicken pox because their immune system has been suppressed by vaccines.

In my closing remark, I urge parents to ask themselves a few questions. Have you noticed how much the vaccines are pushed by threats, coercion, victimisation and monetary punitive measures, with parents then being accused of causing what are clearly side effects of the vaccines? Would you succumb to the same type of pressure if any other product were pushed with the same vengeance? Wouldn't you be suspicious and ask what's wrong with the product if it has to be forced upon consumers? Why do so many informed parents, as well as many informed medical doctors, now refuse vaccination? Shouldn't you be suspicious of a medical system which forces itself upon you, which won't accept

**Those parents who think they are safe when they follow the official propaganda may be in for a rude awakening: they may be accused of causing the harm which resulted from vaccination.**

Continued on page 87







# ~ THE BECK ZAPPER ~

## Renewed Hope Against AIDS

**An inexpensive,  
build-it-yourself  
electromedical  
device is proving  
extremely  
successful in  
neutralising HIV,  
AIDS and other  
diseases.**

by Robert C. Beck, DSc  
© 1991-1997

Website: [www.rarebooks.net/beck/](http://www.rarebooks.net/beck/)

March 20, 1997 (last revision)

*Most men occasionally stumble over the truth, but most pick themselves up and continue on as if nothing had happened.*

— Winston Churchill

Dear fellow researcher,

This "theoretical" information is yours now. But before you start, you may wish to get a PCR test (count of active HIV cells in blood) and a second one 90 days after completion of neutralization. Some show dramatic drops; a few show negative HIV counts. However, in most cases, symptoms vanish or decrease dramatically regardless of test results.

Several subjects (but not all) have shown a *negative* PCR test (polymerase chain reaction; K. Mullis, 1983) after completion, indicating no more active HIV detectable in blood. But it's normal for common HIV *antibody* tests to remain the same even after complete remissions, just as you will always carry specific antibodies if you've once had childhood diseases like measles, chicken pox or mumps. Many other diseases including cancer may vanish with electrification and silver colloid ingestion plus ozone water detoxification.

This very slight and mild electrification of your blood does not kill any viruses or harm normal blood cells. Instead, the minute currents appear to alter and inhibit the ability of the outer protein layer of the virus to attach to lymphocytes (reverse transcriptase process). This blocks the binding of the HIV virus with the host cell (thymic-T lymphocyte; CD4 T-helper cells) so the virus is thought in effect to be neutralized, immobilized and eventually eliminated from the body. Rate of recovery is the product of current intensity multiplied by time of exposure (Kaali with Lyman and Merkatz, 1994). This communication describes a safe and tested procedure for interrupting HIV reproduction. But you *must* avoid ingesting any medicinal herbs, domestic or oriental, since blood electrification causes electroporation of cell membranes and can thus cause tremendous increase of molecular transport into cells, resulting occasionally in extreme and toxic overdosing. Allow one week to eliminate herbs and other medications from body before blood electrification (see J. C. Weaver, Harvard-MIT Division of Health Sciences and Technology, in *Journal of Cellular Biochemistry* 51:426-435, 1993).

With AIDS, be prepared for a temporary initial *drop* in T-cell count due to lysing (dissolution) of previously infected white cells by treatment-destroyed HIV and its subsequent scavenging by macrophages, since tests count both healthy and infected cells. Also, some patients do not test PCR-negative; however, practically all will experience a dramatic decrease in symptoms. T-cell counts CD4 (T4) may recover and continue to rise dramatically after a few months, since tests count both healthy and infected cells.

When discussing your recovery, please refer to all data and claims as "hypothetical" to avoid entanglement with FDA and legal constraints forbidding use of the word "cures".

If you follow instruction precisely, avoiding herbs and toxic medications, and detoxify properly, you may be symptom-free in a few months, safely and surely. We have numerous reports of complete recoveries when all instructions are followed.

Please share your results with me so as to assist others. Your name will not be used. We still have nothing for sale. So you have nothing to lose, since there is nothing to purchase except a few parts.

With highest regards, and good luck!

Bob Beck

**A PROPOSED EXPERIMENTAL/THEORETICAL,  
NONINVASIVE, NONPHARMACEUTICAL, *In Vivo*  
METHOD FOR RAPID NEUTRALIZATION OF  
HIV VIRUS IN HUMAN SUBJECTS**

Revision, March 20, 1997

by Robert C. Beck, DSc © 1991-1997

**I**n a remarkable discovery at Albert Einstein College of Medicine, New York City, in 1990, it was shown that a minute current (50 to 100 microamperes) can alter outer protein layers of HIV virus in a petri dish so as to prevent its later attachment to receptor sites (*Science News*, March 30, 1991, p. 207). It may also reverse Epstein-Barr (chronic fatigue syndrome), hepatitis and herpes B.

HIV-positive users of this enclosed information may expect a negative PCR test (no more HIV detectable in blood) after 30 days. This is reminiscent of a well-proven cure for snakebite, by application of electric current, that instantly neutralizes the venom's toxicity (*Lancet*, July 26, 1986, p. 229).

And there may be several other as yet undiscovered or untested viruses neutralizable with this discovery—perhaps, more surprisingly, even the common cold. This very simple and valid blood-clearing treatment offered great promise as a positive method for immobilizing known strains of HIV still present and contaminating some European and US blood bank reserve supplies.

It was further suggested that infected human HIV carriers could be cured by removing their blood, treating it electrically and returning it by methods similar to dialysis as described in US Patent #5,188,738. Dr S. Kaali, MD, projected that "years of testing will be in order before such an *in vitro* (blood removed for treatment) device can be made ready for widespread use" (*Longevity*, Dec. 1992).

This paper reveals an alternative "do-it-yourself" approach for electrifying/purifying blood with no dialysis, implants or medical intervention. In the writer's opinion, both blood and lymph can be cleared *in vivo* (which means blood isn't removed or skin ever penetrated), simply, rapidly and inexpensively, with similar but non-invasive techniques described herein. All are fully disclosed in this paper. Also

included are the proven schematic, parts lists, electrode construction details and complete instructions. Electronic and controlled electroporation approaches may well make vaccines, pharmaceuticals, supplements, herbs and diet therapies plus other proposed remedies obsolete, even if they worked and were universally available at no cost.

In a public lecture (Oct. 19, 1991), the writer proposed this theoretical do-it-yourself method for accomplishing HIV, parasite, fungus, virus, pathogen "neutralization" *in vivo*. Subsequently, his original modalities and protocols have been extensively peer-reviewed, refined, simplified and made universally affordable (under US\$75 for both devices, including batteries, when self-made). These two simple treatments used in tandem can potentially nullify well over 95% (and perhaps 100%) of known HIV

strains residing in blood, lymph and other body tissue and fluids.

The following is a summary of several years of offshore feedback with this non-iatrogenic, do-it-yourself, simple and inexpensive experimental solution to the ever-escalating AIDS dilemma. There are no known side-effects, since milliampere currents are much lower than those in FDA-approved TENS, CES and muscle stimulators which have been in use for many years. Battery replacement costs are minimal for a typical 21-day "spontaneous remission". No doctors, pharmaceuticals, shots, diets, medications or other interventions appear to be necessary.

One compact, battery-powered, blood-clearing instrument is basically a miniature relay driven by a timer chip set to ~4 hertz. Its 0 to 27 volt user-adjustable biphasic output minimizes electrode site irritation. The described system delivers stimulation through normally circulating blood via electrodes placed at selected sites (such as one electrode behind ankle bone on inside of foot and another on opposite foot) over the sural, popliteal, posterior tibial, or peroneal arteries where the subjects' blood vessels are

accessibly close to the surface, or on the wrist or arm. Optimum electrode positions are reliably located by feeling for strongest pulse. Microcurrent treatment is of such low amplitude that it creates no discomfort when used as directed, and is demonstrated to have no harmful side effects on healthy blood cells or tissue. However, a major obstacle to this simple and obvious solution is contrived aversion and disbelief.

Treatment for approximately 120 minutes per day for four or six weeks should, in the writer's opinion, effectively neutralize well over 95% of any HIV and, simultaneously, any other electrosensitive viruses, parasites, bacteria or fungi in blood. In heavy infections, shorter application times could prevent overloading patients with toxins: simply treat for a greater number of days or ingest ozonized water.

In time, the restored immune system plus ingested silver colloid may handle residual problems. In the special case of diabetically impaired circulation, longer treatment times may be indicated. Immobilized viruses may be expelled naturally through the kidneys and liver. More rapid neutralization is possible but not recommended because of potential excessive toxic elimination

reactions (Herxheimer's syndrome). T-cell counts may drop initially because of lysing and subsequent scavenging by macrophages, but should recover and increase after a few months. Even negative PCRs are sometimes reported.

Latent/germinating HIV reservoirs in the body's lymph or other tissue may theoretically be neutralized with a second and separate device by the strategy of generating a very high intensity (~10 kilogauss), short duration (~10  $\mu$ s) magnetic pulse of ~20 joules by discharging a modified strobe light's capacitor through an applicator coil held at body points over lymph nodes, thymus, kidneys, adenoids and other possible internal sites of latent infection. By the physics of Eddy current/back EMF "transformer action" (Lenz's law), the desired criterion of minimum current induced through infected tissue in the order of 100  $\mu$ A to 1 mA should be

**This paper reveals  
an alternative  
"do-it-yourself"  
approach for  
electrifying/  
purifying blood  
with no dialysis,  
implants or  
medical  
intervention.**

readily attained. Several pulses repeated at each site may insure a reliable "overkill" for successful disease neutralization.

A magnetic "pulser" is very inexpensive and simple to build. However, subjects must assume responsibility for their own health—a "heresy" in today's society where we're conditioned to look for answers only to a medical establishment that has no current knowledge remotely promising "cures" for numerous other well-known fatal diseases.

These "theoretical solutions" are being disclosed under constitutional freedom-of-speech guarantees in spite of extensively organized hostile opposition to non-pharmaceutical or inexpensive cures. Data can be legally offered only as "theoretical", and no medical claims can be made or implied. See your health professional!

Anyone at his discretion and assumed responsibility should be free to build, use (on himself) and network his "research" results. With these data an average, intelligent high school student should confidently be able to assemble both theoretical blood and tissue clearing modalities in about three hours and for a total investment of around US\$75.00. Components are widely available. If electronically unskilled, "busy" or technically illiterate, call an amateur radio supply store (yellow pages), or find a ham radio operator, hobbyist or TV repairman, or pay any kid on the block to do it for you.

After "spontaneous remissions", some users may wish to interest their doctors. But be advised that electronic cures may be vigorously suppressed or ignored because there is presently no credibility or drug cartel profit in this inexpensive AIDS solution. Also, the 1910 Rockefeller/Flexner Report attempted to discredit electromedicine in a conspiracy to inflate pharmaceutical profits.

I'm definitely not soliciting funds. This was independently developed by Bob Beck at his private expense and offered freely for "theoretical and informational purposes only" and with absolutely no profit motive.

Non-FDA-approved devices are illegal to use within the USA except via little-known FDA regulation loopholes whereby doctors and researchers are allowed to use anything on patients if they build it themselves (Code of Federal Regulations 21, § 807.65, Subpart D, Paragraphs {d} and {f}).

Although we will offer technical updates and always welcome feedback from users, please respect the writer's privacy and never attempt to contact him for additional help or construction information. Everything users need to know is included herein.

We have nothing for sale.

Bob Beck

## EXPERIMENTAL *In Vivo* BLOOD VIRUS, MICROBE, FUNGUS AND PARASITE ELIMINATION DEVICE

Revision, March 16, 1996  
by Robert C. Beck, DSc © 1993-1996

**Note:** These data are for informational, instructional and research purposes only, and are not to be construed as medical advice. Consult your licensed medical practitioner.

**CHANGES** since previous editions: Pulse repetition rate from 0.67 to ~4 Hz (not critical). C2 from 1.0 to 0.22  $\mu$ F. Voltage from 36 to 27 V. Treatment time increased to 2 hours daily for 21 to 30 days. Improved electrode design and single wrist electrode placement. SW2 added to extend battery life. There are no "errors" in this schematic. Hundreds have been constructed successfully when duplicated exactly without user-attempted "improvements".

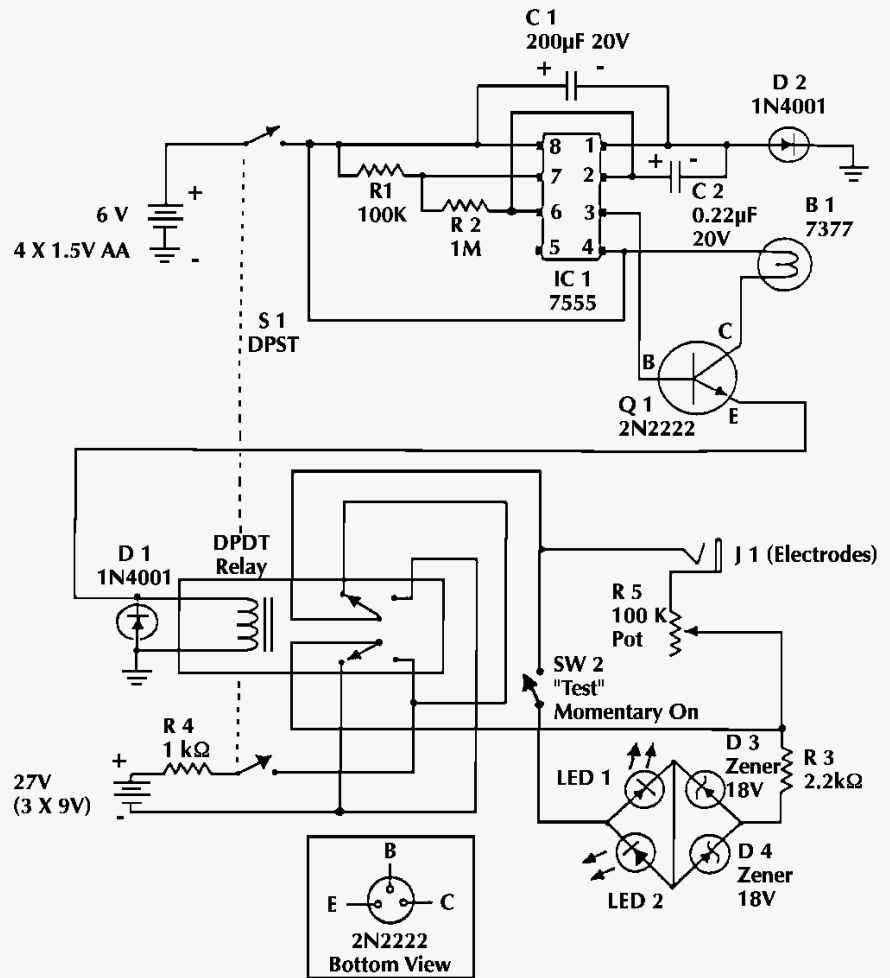

### SPECIAL PARTS

- B1: Filament-type incandescent bulb, 6.3V .075A, type 7377 (ballast & current limiter)
- Relay: 5V 50 coil, PCB mount DPDT, Selecta Switch SR15P207D1
- D3 & D4: Zener diodes, 18V, 2W, NTE 5027A
- R5: 100k 2W linear potentiometer, Caltronics P-68 or equivalent
- LED 1 & 2: Combined as bicolor red & green in same housing, Radio Shack #276-012
- SW2: "Test" SPST momentary on subminiature push-button, Radio Shack #275-1571

## PROPOSED THEORETICAL *IN-VIVO* BLOOD HIV, PATHOGEN AND PARASITE NEUTRALIZING DEVICE

COMPONENT DESCRIPTIONS, SOURCES AND CURRENT PRICES (March 1995)

Revision, March 13, 1996

by Robert C. Beck, DSc © 1991-1996

**Note:** These data are for theoretical, informational and instructional purposes only and are not to be construed as medical advice. Consult your licensed medical practitioner. Some builders have ego problems with following instructions (not invented here) and like to find "mistakes" or possible "improvements". Hundreds of devices have been built successfully, if duplicated exactly as shown. Do not expect this device to function optimally if any electrical changes or ego improvements are attempted.

7555 CMOS timer chip (generic)	IC1	\$ 1.80	
100 k ohm ( ) 3 watt (W) 5% resistor	R1	.07	
1 meg 3 W 5% resistor	R2	.07	
2.2 k 3 W 5% resistor	R3	.07	
1 k 3 W 5% resistor	R4	.07	
100 k linear taper pot, 1/2 watt Caltronics P-68	R5	2.56	
200 µF 20 V (or higher) electrolytic capacitor	C1	.45	
0.22 µF 20 V (or higher) tantalum capacitor	C2	.25	
1N4001 diode	D1 & D2	.30	
18 V Zener diodes, 1/2 watt	D3 & D4	1.58	(NTE5027A)
2 required @ .15			
2 required @ .79			
NPN transistor, generic 2N2222	Q1	.30	
Bulb, 6.3 V 075 A, type 7377	B1	1.34	
Relay, 5 V 50 coil PCB Mount DPDT Selecta Switch SR15P207D1		5.45	
Misc. wire, solder, etc.		.50	
Custom-printed circuit board #PS-PCB		15.00	

Note: All 15 components listed above are available at Action Electronics, 1300 E. Edinger, Santa Ana CA 92705, USA, telephone (714) 547 5169. They also have a complete kit available for about \$80.00.

Bicolor LED red/green, Radio Shack #276-012	LED1	\$ 1.19	
Jack for electrode leads, #274-251, 3 for \$1.59	J1	.53	
DPDT switch, #275-626 or equiv. (used as DPST)	SW1	2.55	
SPST Submini momentary push button switch	SW2	.59	(ER-SW101 "Test")
Battery holder, 4 AA cells, Radio Shack #270-383		1.29	
4 Alkaline AA cell batteries, #23-552		2.89	
3 Alkaline 9-V batteries, type 1604, etc.		3.75	
3 9-V battery snaps (clip-on connectors), #270-325, pkg 5 for \$1.29		1.29	
Box, if used		2.29	

Note: The above items are generally available at local Radio Shack stores.

Lead wire with 3.5 mm plug, 6 ft, Mouser or Calrad Electronics	\$ .35	
Electrodes, stretch elastic, Velcro, cotton flannel, alligator clips, etc.	<u>± 5.00</u>	(see notes)
Total cost for all components for do-it-yourself project	\$49.24	

This design is basically a 7555 IC timer chip set for 50% duty cycle and ~3.9 Hz driving a subminiature relay. Electrode polarity continually reverses: ~1/4 second positive / 1/4 second negative. Frequency is not critical.

Patents applied for.

### Footnote:

CODE OF FEDERAL REGULATIONS 21 § 807.65 Subpart D – Exemptions, Paragraphs {d} & {f}

Excludes and exempts from regulation:

"(d) Licensed practitioners, including physicians, dentists, and optometrists, who manufacture or otherwise alter devices solely for use in their practice."

"(f) Persons who manufacture, prepare, propagate, compound, or process devices solely for use in research, teaching, or analysis, and do not introduce such devices into commercial distribution."

Use of this device therefore appears legal and exempt from FDA regulations when you construct it yourself for research and/or use in your own practice! But double-check your local, county and state regulations for possible exceptions.

## EXPANDED INSTRUCTIONS FOR EXPERIMENTAL/ THEORETICAL HIV BLOOD NEUTRALIZATION Hypothetical Protocols for Experimental Sessions

Revision, March 20, 1997

by Robert C. Beck, DSc ©1991-1997

**P**RECAUTIONS. Do *not* use wrist-to-wrist with subjects with cardiac pacemakers. Any applied electrical signals may interfere with "demand"-type heart pacers and cause malfunction. Single wrist locations should be acceptable. Do *not* use on pregnant women or while driving or using hazardous machinery.

Users *must* avoid ingesting anything containing medicinal herbs (foreign or domestic) or potentially toxic medication, or nicotine, alcohol, recreational drugs, laxatives, tonics and certain vitamins, etc., for one week before starting, because blood electrification can cause electroporation which makes cell membranes pervious to small quantities of normally harmless chemicals in the plasma. The effect is the same as extreme overdosing, which may be lethal. (See Weaver, J. C., "Electroporation: A General Phenomenon for Manipulating Cells and Tissues", *Journal of Cellular Biochemistry* 51:426-435, 1993.) Effects can mimic increasing dosages manyfold. Both the magnetic pulser and blood purifier cause electroporation.

Do *not* place electrode pads over skin lesions, abrasions, new scars, cuts, eruptions or sunburn. Do *not* advance output amplitude to uncomfortable levels. All subjects will vary. Do *not* fall asleep while using. The magnetic pulser should be safe to use anywhere on the body or head.

Avoid ingesting alcohol 24 hours before using. Drink an 8-ounce glass of distilled water 15 minutes before and immediately following each session, and drink at least four additional glasses daily for flushing during "neutralization" and for one week thereafter. This is *imperative*. Ignoring this can cause systemic damage from unflushed toxic wastes. When absolutely essential drugs must be ingested, do so a few minutes after electrification, then wait 24 hours before the next session.

If the subject feels sluggish, faint, dizzy, headachy, light-headed or giddy, nauseous, bloated or has flu-like symptoms or rashes after exposures, reduce pulsing per session and/or shorten applications of electrification. Drink more water—preferably ozonized—to speed waste oxidation and disposal. Use extreme caution when treating patients with impaired kidney or liver function. Start slowly at first, like about 20 minutes per day, to reduce detoxification problems.

To avoid shock liability, use batteries only. Do *not* use any line-connected power supply, transformer, charger, battery eliminator, etc. with the blood-clearing device. However, line supplies are okay with well-insulated magnetic pulse generators (strobe lights).

Health professionals: avoid nicotine addicts, vegans and other unconsciously motivated death-wishers and their covert agendas of "defeat the healer". Tobacco, the most addictive (42 times

more so than heroin) and deadly substance of abuse known, disrupts normal cardiovascular function. True vegetarian diets are missing essential amino acids absolutely necessary for the successful rebuilding of AIDS-ravaged tissues. Secondary gains (sympathy/martyrdom, work avoidance, free benefits, financial assistance, etc.) play large roles with many AIDS patients. "Recovery guilt" as friends are dying has even precipitated suicide attempts masked as "accidents". Avoid such entanglements, since many have unconscious death wishes.

**SUPERIOR ELECTRODES.** Excellent, convenient and vastly superior electrodes, reusable indefinitely, can be made by butt-soldering lead wires to ends of 1-1/8-inch long by 3/32-inch-diameter blanks cut from type 316 stainless steel rods available from welding supply stores (e.g., Cameron Welding Supply, 11061 Dale Ave, Stanton, CA 90680). Use Stay Clean flux (zinc chloride/hydrochloric acid) before soldering.

Shrink-insulate *two* tight layers of tubing over soldered joints to prevent flexing/breaking and lead/copper ions from migrating. Wrap three or four turns of 100% cotton flannel around rods.

Spiral-wrap with strong thread starting from wire side to end. Tightly pinch cloth over the rod's end so as to leave no metal exposed by wrapping six or seven turns of thread *tightly* just off the end of the rod, then spiral-wrap back to start and tie tightly with four knots. Cut off excess cloth at end, close to pinch wraps.

Treat end windings and knots with clear fingernail polish or Fray Check® (fabric and sewing supply stores) to prevent unravelling. Soak in a strong solution of sea salt (not table salt) containing a little wetting agent like Kodak Photo Flow, ethylene glycol or 409 kitchen cleaner. Add a few drops of household bleach, silver colloid, etc., for disinfectant. Store solution for reuse.

Tape soaking-wet electrodes tightly over pulse sites with paper masking or Transpore™ tape, or with one-inch-wide stretch elastic bands with tabs of Velcro® at ends to fasten. Electrodes should closely conform precisely along blood vessels, not skewing ever so slightly over adjacent flesh. This insures better electrical conductivity paths to circulating blood and insures very low internal impedance (~2,000 watts). Rinse and blot-dry electrodes

and skin after each use. *Never* allow bare metal to touch skin, as this will cause burns manifested as small red craters that heal slowly. The objective is to get maximum current into blood vessels, not to leak it over to adjacent tissue.

**ELECTRODE PLACEMENTS.** Locate maximum pulse position (not to be confused with acupuncture, reflexology, Chapman points, etc.) on feet or wrists by feeling for maximum pulse on inside of ankle, approx. one inch below and to rear of ankle bone, then test along top center of instep. Place electrode on whichever pulse site on that foot that feels strongest. Scrub skin over chosen sites with mild soap and water or alcohol swab; wipe dry. Position the electrodes lengthwise along each left and

...blood electrification  
can cause electro-  
poration which makes  
cell membranes  
pervious to small  
quantities of normally  
harmless chemicals  
in the plasma.

right wrist's blood vessel. Note: with subjects having perfectly healthy hearts and not wearing pacers, it is convenient to use left wrist to right wrist exactly over ulnar arterial pulse paths instead of on feet. Recent (Dec. 1995) research suggests that placing both electrodes over different arteries on the same wrist works very well, avoids any current through heart, and is much more convenient and just as effective. An 8-inch-long, 1-inch-wide elastic stretch-band with two 1-inch lengths of wide Velcro® sewn to ends of opposite sides makes an excellent wristband for holding electrodes snugly in place.

With electrode cable unplugged, turn switch *on* and advance amplitude control to maximum. Push momentary SW2 "Test" switch and see that the red and green light-emitting diodes flash alternately. This verifies that polarity is reversing approx. four times per second (frequency is *not* critical) and that the batteries are still good. When LEDs don't light, replace all three 9-volt batteries. When the white incandescent bulb dims or appears yellowish, or relay isn't clicking, replace all four AA cells. Zener diodes will extinguish LEDs when the three 9-volt batteries' initial 27 volts drop below 18 volts after extended use. Never use any electrode larger than 1-1/8" long by 1/8" wide to avoid wasting current through surrounding tissue. Confine exactly over blood vessels only. Apply drops of salt water to each electrode's cotton cover approximately every 20 minutes to combat evaporation and insure optimum current flow. Later devices are solid-state, use only three batteries and no relays, and are much smaller.

Now rotate amplitude control to minimum (counter-clockwise) and plug in electrode cable. The subject now advances the dial slowly until he feels a "thumping" and tingling. Turn as high as tolerable, but don't advance amplitude to where it is ever uncomfortable. Adjust voltage periodically as he adapts or acclimatizes to current level after several minutes. If the subject perspires, skin resistance may decrease because of moisture, so setting to a lower voltage is indicated for comfort. Otherwise, it is normal to feel progressively less sensation with time. You may notice little or no sensation at full amplitude immediately, but feeling will begin building up to maximum after several minutes, at which time amplitude must be decreased.

Typical adapted electrode-to-electrode impedance is in the order of 2,000 W. Typical comfortable input (to skin) is ~3 mA, and maximum tolerable input (full amplitude) is ~7 mA, but this "reserve" margin, although harmless, is unnecessary and can be uncomfortable. Current flowing through blood is very much lower than this external input because of series resistance through skin, tissue and blood vessel walls, but 50 to 100 µA through blood is essential.

Apply blood neutralizer for about two hours daily for approx. two months. Use judgment here. The limiting factor is detoxification. Carefully monitor subject's reactions (discomfort, catarrh, skin eruptions, weeping exudates, rashes, boils, carbuncles, coated tongue, etc.). With very heavy infections, go more slowly so as not to overload the body's toxin disposal capability. With circulation-impaired diabetics, etc., you may wish to extend session times. Again, have the subject drink lots of water.

Recent changes in theoretical protocol being currently tested suggest following up the three weeks of treatments with a 24-

hours-per-day (around the clock) continuous electrification of blood for two days to deal a knockout blow to the remaining HIV's 1.2-day life cycle (Perelson, A., Los Alamos Biophysics Group, *Science Journal*, March 16, 1996). Remember to remoisten electrodes regularly. If you absolutely must ingest prescription drugs, do so immediately after turning off instrument and allow 24 hours before next treatment to let concentrations in blood plasma decay to lower levels.

Remember, if subjects ever feel sleepy, sluggish, listless, nauseous, faint, bloated or headachy, or have flu-like reactions, they may be neglecting sufficient water intake for flushing toxins. We interpret this as detoxification plus endorphin release due to electrification. Let them rest and stabilize for approx. 45 minutes before driving, if indicated. If this detoxing becomes oppressive, treat every second day. Treating at least 21 times should "fractionate" both juvenile and maturing HIV to overlap maximum neutralization sensitivity windows and interrupt "budding" occurring during HIV cells' development cycles.

Treatments are claimed to safely neutralize many other viruses, fungi, bacteria, parasites and microbes in blood. See US patents #5,091,152, #5,139,684, #5,188,738, #5,328,451 and others, as well as numerous valid medical studies which are presently little known or suppressed.

Also, ingesting a few ounces of approx. five parts per million of silver colloid solution daily can give subjects a "second intact immune system" and minimize or eliminate opportunistic infections during recovery phase. This miracle substance is pre-1938 technology and, unlike ozone, is considered immune from FDA harassment. Silver colloid can

easily be made at home electrolytically in minutes and in any desired quantities and parts-per-million strength for under one cent per gallon plus cost of water. It is ridiculous to purchase it for high prices. Colloid has no side effects and is known to eliminate rapidly or prevent hundreds of diseases. Silver colloids won't produce drug-resistant strains as will all other known antibiotics. No reasonable amount can overdose or injure users either topically, by ingestion or by medical professional injection.

**Treatments are claimed to safely neutralize many other viruses, fungi, bacteria, parasites, and microbes in blood.**

**FOR THOSE WHO DO NOT WISH TO MAKE THEIR OWN 'BECK ZAPPERS', THERE ARE PRE-MADE MODELS AVAILABLE. WE ARE AWARE THAT THE FOLLOWING BUSINESSES MAY BE ABLE TO ASSIST YOU WITH LOCATING SUCH A DEVICE:**

- **In Australia:** Natural Therapy Products, PO Box 252, Turramurra, NSW 2074, phone (02) 9983 1299; or Exclusive Products, PO Box 1000, Indooroopilly Centre, Qld 4068, phone (07) 3371 6126
- **In USA:** SOTA Instruments, Inc., phone 1800 24 0242 (toll free) or (604) 244 0214, website, [www.sota-inc.com](http://www.sota-inc.com)
- **In UK:** Commercial Science, 11 Hylands Close, Crawley, Sussex RH10 6RX, phone 01293 446244
- **In New Zealand:** Altered States, 4 Gundry Street, Newton, Auckland, phone (09) 309 6275







## HOW TO RUN YOUR CAR ON ZERO-POINT ENERGY

by Barry Hilton © 1998

**D**uring 1996 I was given a home-made videotape featuring an Australian researcher who claimed to have run a car without petrol, using a device that appeared to produce either hydrogen or Brown's Gas from water. As I was interested in recent developments in America on point-of-application production of gas as a fuel source (energy cell), I followed up on this interesting phenomenon with a paper summarising what I had seen.

Eventually a copy fell into the hands of the inventor. I then received a call from him, explaining that some of my assumptions had been incorrect. He then offered to visit me in Melbourne to put things right. I was thrilled at the opportunity of gaining some first-hand information about his discoveries and the possibility of filling in the missing blanks. He did not disappoint me.

### THE MARK I ENERGY CELL

Joe "X" first became interested in trying to provide an alternative fuel system in about 1991. He got the idea of running his car on steam produced by a closed stainless steel cylinder containing a perforated cylindrical element.

He thought that if he connected a 12-volt battery with one terminal to the outer cylinder (+) and the other terminal to the centre tube (-), the water would boil and he could draw off the steam from an outlet in the

cell and feed it into the inlet manifold to run the car.

The cell was about 4 inches in diameter (100 mm) and about 3 feet long (870 mm), being made out of a stainless steel tube (from an old milking machine) with screw caps on either end. On one end was a clear glass window (for observing the milk flow in the pipe). On the other end, Joe fitted a circular piece of clear perspex (Plexiglas) through which he fitted a terminal for the inside stainless steel perforated element. This element was about 3.5 inches (87 mm) in diameter and about 2 feet long (600 mm). The element was perforated with 8-mm diamond-shaped holes at 12-mm centres. An outlet pipe was already fitted approximately two-thirds of the way along the outer cylinder. He intended to use it to take off the steam.

On 9 October 1991, on the front lawn of his home, Joe set up the entire arrangement on a pair of wooden saw trestles at the front of the car. He connected a half-inch clear plastic hose from the outlet pipe of the cell to the carburettor preheating device on the car, thinking that this device provided a gas supply to the inlet manifold. The car used was a Rover V8 3500 SD1 with a fully sealed all-aluminium motor. The carburettor was a twin Zenith single-barrel arrangement, similar to the SU carb.

On connecting a separate 12-volt battery to the cell, he noticed through the observation windows that the cell was full of white bubbles with a white vapour coming from

the surface of the water, which he assumed was steam. He then started the car on petrol as usual. After running the car on idle for a short time, he disconnected the petrol supply and the car continued to idle even after the float bowl had emptied. However, the engine did not run smoothly so Joe advanced the timing by approx. 80° to bring the motor back to a normal, smooth idle. He let the car run for some time, thinking that it was running on steam, before he disconnected the battery to the cell to stop the engine. To his amazement the car continued to idle, even though he had disconnected the cell from the power supply! Only when he turned off the ignition key was he able to stop the engine. He found that he could start the car via the starter motor without petrol and without connecting the cell to the battery!

Some readers may have realised by now that the preheating device makes no gas connection into the inlet manifold. In fact, it goes nowhere except to the outer casing of the carburettor housing.

What Joe has discovered here sets the mind boggling. This means that no explosive gas is supplied by the fuel cell to the manifold at all. The only gas entering the engine is plain air. Because this engine runs without mixing any conventionally known fuel with the air entering the carburettor, its fuel must be derived from a different source. Either Joe was controlling this engine by mind over matter, or he had unwittingly devised a means of tapping raw

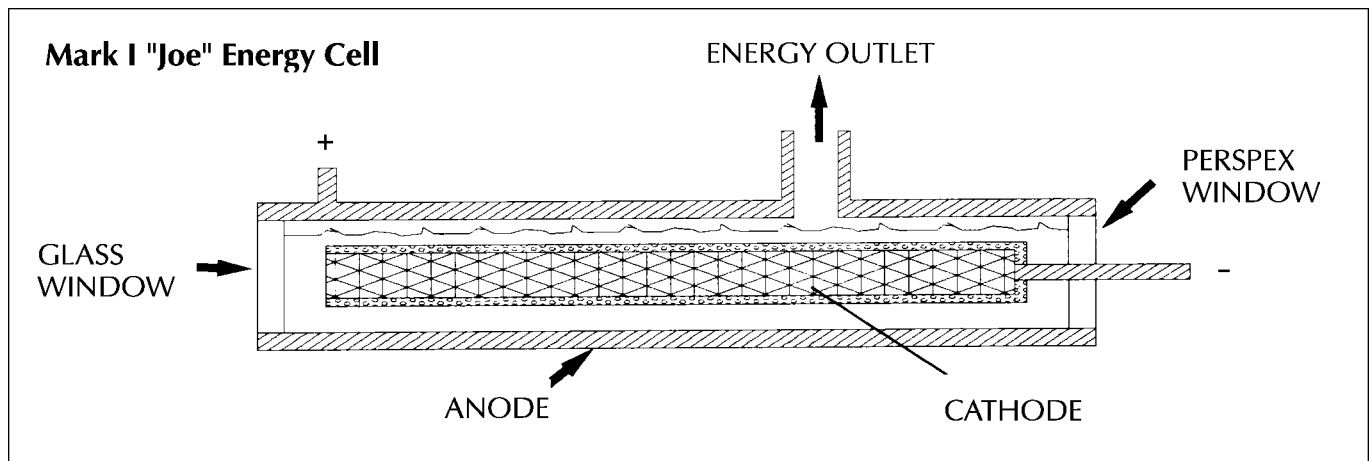

energy to supply the motive power. Joe makes no claims of extrasensory power, and is as baffled by the phenomenon as those who have witnessed it. He has no idea why it works; he only knows that it does.

To date, he has successfully converted at least 14 vehicles (one of them a record-breaking dragster). None of the vehicles had direct fuel-flow connection to the input manifold, with the exception of a Leyland which was fitted with the Mark II cell.

It would seem that Joe has tapped into some form of zero-point energy. (Zero-point energy is created by differences in the "fluoroplasmic density" of the energy continuum or ether.) Whether or not the energy or gas transmitted to the engine block via the plastic hose in some way chemically changed the air entering the manifold into an explosive mixture is still uncertain. If this is the case, then nitrogen is probably the most likely element to have been affected in combination with oxygen and carbon residue to form an implosive/explosive mixture similar to nitroglycerine. What appears to occur within the engine cylinders is either implosion, explosion or both. However, this is pure speculation.

Joe later modified his Mark I cell. He found that a smaller unit was just as efficient as the longer one, and was also easier to fit in the car. He reduced its length to approx. 18 inches (435 mm) and fitted it into the Rover, either in the boot or on the floor next to the driver.

He later drove this car, fitted with the cell, from his home in northern New South Wales to Melbourne, Victoria, and back. This is an achievement that is so remarkable it is almost unbelievable. He also

went on a five-day trip to Toowoomba, Queensland, and back to his home in NSW without any trouble driving the car on his water cell. However, there was a small problem, Joe said, that if the cell was left overnight it would discharge and require recharging by connecting the 12-volt battery for approx. three minutes before it could be used to drive the vehicle. Joe also found that the clear plastic hose connecting the cell to the carburettor was unsuitable. This will be discussed in the next section.

The Rover, having an all-aluminium motor, normally has its timing set at 0° before TDC [top dead centre], but when running entirely on the "Joe Cell" it required an advance of 80°. Joe pointed out that each type of motor required different timing settings. It may also be necessary to cut back on the idle screw-settings to prevent over-revving. This engine, Joe said, showed no signs of pollution nor exhaust emissions of any kind. During the entire time the car was used with the cell, the temperature gauge never moved off zero. The motor was cold, the exhaust was cold and the radiator was cold.

With Joe's permission, Prof. Ron Davis (now deceased) of Newcastle University carried out extensive research on the Rover and Joe's cell design. Prof. Davis solved the discharge problem by installing a 1.5-volt DC battery to the cell when not in use (with negative to earth and positive to the cell casing). Joe found that no power was drawn from the battery as a result of the connection. He also recounted that the vehicle received a tremendous boost in power when the 1.5-volt battery was connected for a few seconds across the cell whilst the vehicle was being road-tested.

Joe's latest cell design does not discharge if left overnight, so the small DC battery is no longer needed.

## THE MARK II ENERGY CELL

Joe's next cell was radically different from his Mark I cell. In the Mark II cell he used seven flat circular plates in a row. These stainless steel plates, approx. 2 mm thick and 100 mm in diameter, were packed into a short length of black corrugated PVC agpipe. About one-third of its radius was removed to allow the gas to escape from above the plates. The entire assembly was then placed inside a PVC 120-mm-diameter "T" junction, with one plate positioned in each corrugation, giving a plate spacing of approximately 3/8ths of an inch (8 mm). Both ends of the straight through section were sealed off with end caps. The stainless steel plates on both outside positions were positively charged, whilst the centre plate was negatively charged. The two intermediate plates on either side had no electrical connections. Joe calls these "neutral" plates.

By a process of experimentation, Joe showed that less amperage was required to charge a cell with neutral plates than one fitted with only a cathode and anode, yet gas production seemed much improved in the cell with neutral plates. Joe discovered the optimum performance was achieved by a cell with two neutral plates on either side of the cathode, and two anode plates on the outside of the set. Joe explained that he tested this cell in a Leyland P76 V8 which has an all-aluminium motor. Unlike the Rover, this engine is not hemispherically sealed. In this connection, Joe fitted the output hose from the cell directly into the carburettor via the tappet cover vacuum fitting under the carby.

The Mark II cell in this engine performed very badly. On a test drive to Lismore in 1992, Joe discovered that on applying acceleration the PVC cap (through which the gas/energy passed) would bulge outward in excess of an inch, and whilst decelerating the cap would return to its normal shape. But due to the extra gas/energy contained within the cell under pressure, motor acceleration could not be accurately controlled.

Joe assumes that when acceleration is applied to draw more gas/energy from the cell under inlet manifold vacuum, a chain reaction is activated within the cell, giving more gas/energy and providing an excess of pressure within the cell. Upon decelera-

## Mark II "Joe" Energy Cell

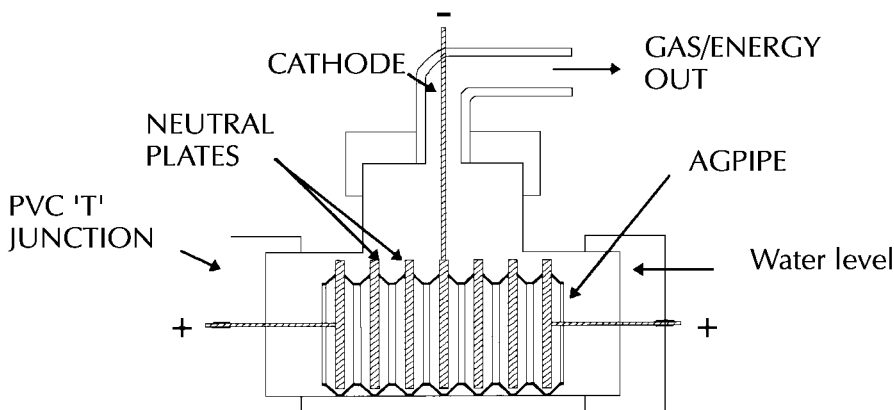

tion, the cell is again subjected to electrostatic surface tension. The excess gas/energy stored within the cell is therefore transferred to the input manifold due to the high buildup of pressure within the cell. As a result, car speeds cannot be regulated efficiently.

Joe also reported that Prof. Davis had constructed a test cell shaped similarly to a car air filter and built with a thin outer casing of stainless steel. When tested on a car, it suffered the same problem as Joe's plastic cell. The gas/energy pressure in this cell changed its shape from a flat disc to almost a complete sphere. It is a wonder these cells did not explode!

Joe concluded that both the casing of the cell and the gas/energy transfer pipe needed to be constructed of rigid, robust material for the cell to operate efficiently without expansion and contraction of the parts. Although this cell provided the necessary energy to drive the V8, it proved too dangerous for further use.

## THE MARK III ENERGY CELL

Joe then decided to use concentric cylinders with a thick stainless steel container, based on the same idea as the Mark II cell. This new design would therefore incorporate the advantages of his original Mark I cell with the concept of neutral plates.

Joe also discovered that the cell had more power when the cathode was electrically connected to the bottom of the cell. By this method, the energy field was generated over the entire surface of the cylinders. When the connection was made at the top of the cathode, only the top half of the cell seemed to be active.

So, the Mark III cell consisted of five concentric circular cylinders. The central cylinder, of approx. one-inch diameter, was electrically connected through the bottom of the cell as the cathode, but insulated from the outer casing. Then came three neutral cylinders, measuring two, three and four inches diameter, of equal height to the cathode and arranged concentrically outward from the centre, each providing approximately a half-inch gap between cylinders. The fifth cylinder formed the outer casing of stainless steel (minimum 3 mm thick) and surrounded the entire assembly. The plates inside have to be

machined exactly to the same length, with great care taken to ensure that all the cylinders line up precisely level. The top of the anode outer casing also needs to be either conical or domed in shape in order to direct the energy to the opening at the top. The top and bottom of the inside set of cylinders should not be closer than one inch from the anode casing. However, the gap between the anode and the outer neutral cylinder can be as close as half an inch and maybe as wide as two inches. Joe said this outer gap was not important as long as it was not too close.

Each of the cylinders needs to be separated by the best insulators available that will not react with the energy fields inside the cell. Synthetic insulators, made of plastics, nylon, teflon and the like, appear to be unsuitable because a conductive path soon develops across these insulators, resulting in a dead short between the cylinders and destruction of the energy fields developed in the water between the plates.

I have examined a number of cells used by experimenters trying to duplicate the Joe phenomenon. These cells had been in use for some time, and when dismantled the cylinders showed deep pitting in the area around where the insulators had been located.

In his cells, Joe used the black rubber tubing that is normally laid on the roads for traffic counting. Unfortunately, most of the road authorities have converted to synthetic material, which is not suitable for the cell. As a substitute, I have tried the pure rubber stoppers used in chemical laboratory

experiments and as acid bottle-stoppers. These stoppers are solid rubber (without a hole in the middle to trap conductive elements). They appeared to resist conductive outer growths up to 60 volts DC when tested for five days of continuous charging. No pitting was observed and adjoining plates still showed open circuit readings.

When charging the water in the same cell as to be used in the car, make sure the sediment formed on the surface of the water does not settle on these insulators, as this coating will soon form a conductive path over the rubber. This is one reason why Joe decided to use a separate water-charging vat.

When mounting the rubber stoppers (or pure rubber solid circular rod) between the plates, the round section of the rubber should be fitted horizontally between the plates, with the flat part against the cylinders. This will prevent sediment being trapped between the curved side of the rubber and the plate surface.

Joe uses the minimum number of separators that will maintain correct plate distances: three insulators at the top of the cylinders and three more at the bottom. Each of the rubbers should be mounted-in approx. 5 mm from the edge of each cylinder and arranged radially outward in three straight lines at 120-degree intervals. The rubbers, if cut slightly oversize, will hold the assemblies firmly in place to withstand car vibration.

The trick, when assembling, is to mount one rubber on the centre tube first, then squeeze the first two cylinders together

## Mark III "Joe" Energy Cell

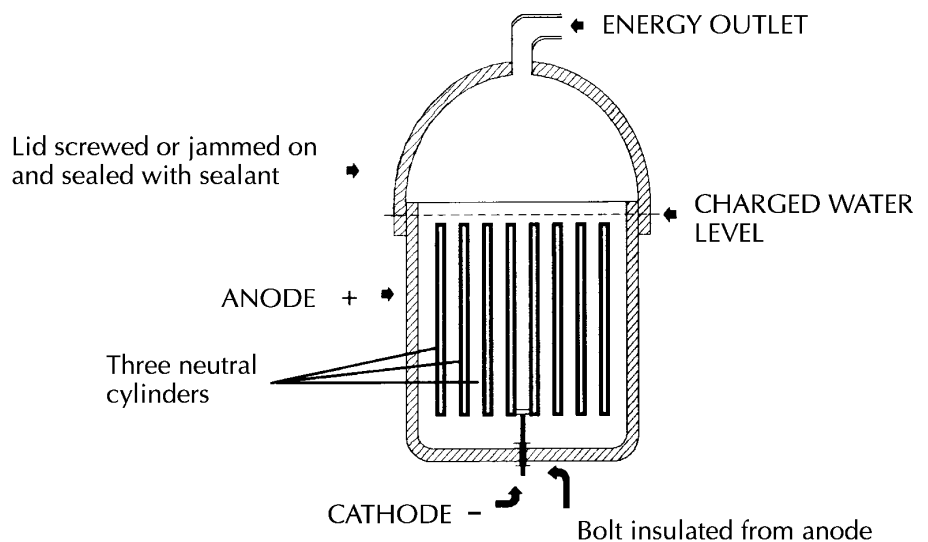

# NEWSCIENCE NEWSCIENCE NEWSCIENCE

with round-nosed pliers (or multigrips) over the insulator. Then insert the other two rubbers in sequence. The setting need not be perfect as it can be adjusted after the three rubbers are fitted to the opposite end. But do the spacing adjustment, if necessary, before fitting the next outer cylinder. If you don't, you may have to do the job all over again. Make sure that, when finished, all of the cylinders sit flat on a level surface without any one cylinder protruding above the others. If you are not careful about this point, the energy-multiplying factor may miss the lower plates (cylinders) entirely, thus reducing cell efficiency.

If your cathode terminal bolt has been fitted correctly, then the entire assembly can be supported by the locking nuts on the cathode terminal bolt. However, if you feel that your plate assembly requires some additional support, a slot can be cut into the bottom of three more rubber stoppers. These stoppers (correctly spaced) can then be fitted to the bottom of the outer neutral cylinder to act as supporting stand-offs inside the anode casing. An insulating sleeve should be inserted into the hole drilled in the anode through which the bolt passes, and insulating washers also fitted either side of the hole. Seal the hole with white marine-grade Sikaflex.

All metal parts, except for the energy transfer tube, should be made of food-grade stainless steel and must be diamagnetic. Grade 316 is the most appropriate stainless steel to use. Make sure you test it for paramagnetic properties before you buy it. It must not attract a ferrite magnet or deflect a

compass needle even slightly, or you are just wasting your time and money. All stainless grades show some attraction if neodymium magnets are used.

I am uncertain which vehicles the three-neutral-plate system was fitted to, or how each vehicle performed. What I do know from Joe is that over the last few years he has successfully converted a number of common vehicles such as Fords and Holdens. After the Leyland, he experimented with solid supply tubes to transfer the energy from the cell to the carburettor. He also abandoned any further attempts to connect the cell directly to the input manifold, preferring instead to locate the end of the transfer tube on a sealed blank fitting on the carburettor housing. However, as there may still be some danger of pressure building up within the cell, Joe said it is a good idea just to slide the end of the outlet hose over the blank fitting without securing the end of the hose with a pressure clip or sealing compound.

In the early stages Joe replaced the clear plastic tubing from the cell to the carburettor with a length of copper pipe, but discovered that the copper corroded at the cell end. Eventually he settled for an aluminium pipe of approximately 3/4-inch diameter. The pipe is screwed to the top of the cell's outlet connection (metal to metal). The furthest end of the pipe (nearest the carburettor) is cut short about four inches, and a good-quality rubber hose fitted to the end of the pipe to make up the last four inches to the carburettor blank.

According to Joe, aluminium is the best material for conveying the energy to the engine as it does not corrode as a result of cell action. The rubber at the end of the tube insulates the cell body from the car block.

Joe states that although the cell has no electrical (closed circuit) connection to the battery, the cell body has a positive charge which, if allowed to make metal-to-metal contact with the car body, would dis-

charge the cell. It would then have to be cleaned and filled with freshly charged water or recharged from the battery, although just recharging may not suffice. Joe no longer recommends recharging the cell from the battery, as the cell may become contaminated and may not work at all until it has been cleaned and regenerated. The Mark I cell that was recharged by the car battery consists of only the anode and cathode. There are no neutral plates or separators (insulators) to cause problems through contamination or shorts.

As the transfer tube has a positive charge and carries the energy field to the motor, it is most important that the cell *not* be located near any other field generators such as distributor coil, cut-out points, alternator, electronic circuitry or high-tension leads. The transfer tube must also be well insulated from the car body.

Joe recommends that the cell be either located on the floor next to the driver (with the cathode bolt electrically connected to the car chassis) or placed in the boot away from electrical wiring. If the cell is located in the boot, the entire length of the transfer tube should be insulated with a plastic tubing sheath to avoid contact with the negatively charged body. If placed next to the driver, the transfer tube should be passed through a hole in the firewall fitted with a suitable rubber insulating grommet.

By a process of experimentation, Joe found that a two-neutral-plate cell worked just as well in a car as did the three-neutral-plate system, and maybe even better. However, the two-neutral-plate system required that the water first be charged in another charging cell for the system to work effectively. By pre-charging the water in his vat system, he was able to carry out the process much more efficiently than if he used the actual car cell to effect the charging process. It is for this reason that Joe uses only two neutral plates in his most recent car cells.

## Editor's Note:

Additional details are covered in Barry Hilton's 40-page book, *The Joe Phenomenon: How to Run Your Car on Zero Point Energy*. Copies are available from the publisher, NuTech 2000, PO Box 255, Ivanhoe, Vic. 3079, Australia; telephone/fax +61 (0)3 9457 2814, e-mail, <nutech@arc.net.au>. Price: AUD\$39.00 ppd in Australia; foreign orders, USD\$41.00 ppd, or payment by credit card.







# SUPPRESSED EVIDENCE FOR ANCIENT MAN IN MEXICO

*The discovery of tools among fossilised mammoth bones, dated at least 250,000 years old, extends the history of humans in the Americas well beyond the dates accepted by establishment science.*

by Virginia Steen-McIntyre,  
PhD © 1998

PO Box 1167  
Idaho Springs, CO 80452, USA  
E-mail: dub.ent@ix.netcom.com

**W**as someone actively hunting mammoth in Mexico a quarter-million years ago? In this article I give the geologic evidence for such a presence and relate the 25-year ongoing battle I've had with the establishment to get the information out to the public.

So, 250,000 years ago—not 25,000, but 250,000. Closer to 275,000, actually—at least that's where the radiometric dates seem to cluster: zircon fission-track dates from two of the overlying volcanic units, and two uranium-series dates from a butchered camel skeleton that was found lying next to some well-made stone tools. No <sup>14</sup>C [carbon-14] dates, of course—the site is much too old for that dating method. And that's just for Hueyatlaco (way-at-LA-co), the youngest of the four sites.

Fifteen metres lower in the sedimentary section, exposed only when the water of the reservoir is abnormally low, lies the oldest site, El Horno (el OR-no)—a mastodon kill site, that one, found with a slim stone flake still wedged between two of the teeth. Someone had tried to remove one of the molars. When? According to two uranium-series dates on the tooth, some time more than 280,000 years ago!

"How exciting! A new discovery?" you ask.

No. The uranium-series [U-series] dates were published almost 30 years ago,<sup>1</sup> and the zircon fission-track dates over 17 years ago.<sup>2</sup> But the scientific evidence and radiometric dating methods we geologists used to date the archaeological sites fly in the face of an entrenched theory that has only lately been seriously questioned—a theory that declares that humans have been in the New World (the Americas) only since the end of the last ice age some 10,000 to 12,000 years ago. According to this prevailing view, both our data and our dates are "impossible". Both are ignored by establishment science, and my career as a research geologist is ruined as a consequence.

But for me, some good has come out of this after all. With no career to worry about, no job to protect, no boss looking over my shoulder, I'm free at last to speak my mind. I want to give you the true story about these ancient archaeological sites. Who knows, it may be the only time you'll ever hear it!

## ANCIENT HUNTERS AT VALSEQUILLO

One hundred kilometres east of Mexico City and few kilometres south of the city of Puebla lies the Valsequillo (bal-say-KEY-yo) Reservoir. It nestles in a high mountain valley guarded by some of Mexico's most famous volcanoes: La Malinche, Tlaloc, Iztaccíhuatl and steaming Popocatepetl.

Surrounding the reservoir are low, buffy-tan badlands: thick, eroded deposits of ancient mudflows, lake beds, stream and overbank sediments, and volcanic ash and pumice layers. Grass-covered now, in the 1960s and 1970s when the climate was drier they were sparsely dotted with cactus and other spiny plants of the Mexican high desert.

For over a century the area has been famous with palaeontologists and museums as a collecting locality. Weathering out of these badlands beds are well-preserved remains of an incredibly rich assortment of ice age (Pleistocene) animals: mammoth, mastodon, glyptodont, horse, camel, dire wolf and sabre-toothed cat, to name a few.

Also weathering from these beds, as first noted over 60 years ago by the Mexican prehistorian Juan Armenta Camacho, are man-made artifacts of flaked flint, quartz and bone.

Juan is the original hero of this story. Born and raised in the city of Puebla and of an inquiring mind, as a lad he would often go exploring along the shores of the reservoir and up the arroyos that fed into it. There, in 1935, he found eroding out of a sediment bank in

the Alseeca Arroyo the fossilised leg bone of an elephant-like creature. Firmly embedded in the bone was a flint spearhead.<sup>3</sup> Obviously, someone at some time had actively hunted that animal. But who? And when?

The questions intrigued Juan, and he was hooked. For the next 30 years he spent much of his spare time searching for more evidence of these early hunters. His search was well rewarded. During that time he located well over 100 partial skeletons of butchered mastodon and mammoth as well as many others of the smaller game animals. Missing were the parts rich in meat. Often the bones he found showed signs of human activity. There were intentional cut marks on some of the bones, made during butchering operations. He found splinters of bone, sharpened, smoothed and made into tools; bones cracked to remove the marrow (a food delicacy for primitive hunters even today); a fragment of engraved mastodon pelvis, worked when the bone was fresh; and even a mammoth jaw with an embedded spearpoint.

And what of the archaeological establishment in Mexico City during this time? They ignored Juan and his evidence, declaring that all of it—including the engraving and the spearpoint in the mammoth jaw—was the result of Nature, not Man.

### THE VALSEQUILLO PROJECT

Fortunately the research didn't end there. Other scientists besides the archaeological elite in Mexico City learned of Juan's work. They realised its importance and that an in-depth study of the area was imperative—a study that would include input from archaeology, geology, palaeontology and other more esoteric fields. Wheels were put in motion both in Mexico and in the United States; funds were found; and in 1962 the Valsequillo Project was born.

Cynthia Irwin-Williams, a young anthropologist from Harvard, was tapped to work with Juan. That first summer exploring together, they located four sites on the north shore of the Valsequillo Reservoir where fossilised bones and stone tools occurred together *in situ*—that is, *within* the sediment layers and not just lying loose on the surface. From oldest to youngest, these

sites were El Horno, El Mirador, Tecacoxco and Hueyatlatco.

Hueyatlatco was the one they concentrated on during the ensuing field seasons. It had lots of fossil bones and two distinct artifact types: rather simple-looking tools (unifacial tools), made by chipping the edges of natural stone flakes, found in a lower, older sedimentary layer; and more complexly worked pieces (bifacial tools), found in several upper, younger layers. Capping the artifact-bearing beds was a thick cover of younger sediment that contained several volcanic ash and pumice layers.

Both tool types included projectile points (spearheads) and both were associated with butchered bones from very large mammals such as the mastodon and mammoth. This was exciting news! It meant that the tool-makers, whoever they were, were actively hunting and killing these large prey, not simply cutting up a dead carcass they happened upon.

Next step was to date the Hueyatlatco site, but a problem quickly arose. No carbon (charcoal, wood, shell) had been preserved at any of the four sites including Hueyatlatco. Without carbon there can be no <sup>14</sup>C dates, and <sup>14</sup>C is the common radiometric method used to date archaeological remains in the New World. There was fossil bone in plenty, and bone usually contains carbon, but the bones from these sites had all been permineralised, fossilised, turned to stone. Whatever carbon had been there was now gone.

And the sites just *had* to be dated! Evidence from two other areas in Mexico where ancient stone tools had been found—Caulapan, about five kilometres northeast of Hueyatlatco, and Tlapacoya, south of Mexico City—suggested that Hueyatlatco, the *youngest* of the four sites found by Armenta and Irwin-Williams, could be as old as 22,000 years. This would make it more than twice as old as any date accepted in the 1960s as evidence of humans in the New World. Textbooks would have to be rewritten. It would make our careers!

### TESTS ON THE TEPHRA LAYERS

It was the lack of carbon and the need to date Hueyatlatco that brought me to the project in 1966. I was a young, enthusiastic graduate student at the time—a volcanic ash specialist (tephrochronologist) looking for an interesting research project for my doctoral dissertation.

At the site itself were several overlying younger ash and pumice layers (tephra layers). The surrounding badlands contained hundreds of other volcanic deposits. On nearby La Malinche volcano, the project geologist Hal Malde had already dated a series of tephra layers by the <sup>14</sup>C method, using charcoal from the carbonised logs they contained.

Employing the microscope techniques I had learned at the university, I was certain I could help the other project scientists date their butchered bones and stone tools. I would match up the undated volcanic layers at the site with the dated layers on the volcano. Find even one match, and I had a pair of samples that came from the same eruption. Same eruption, same date. The site would then be dated indirectly. Simple—or so I thought!

So my work began. Years went by. I examined tens of samples, hundreds of samples! No luck. No correlation.

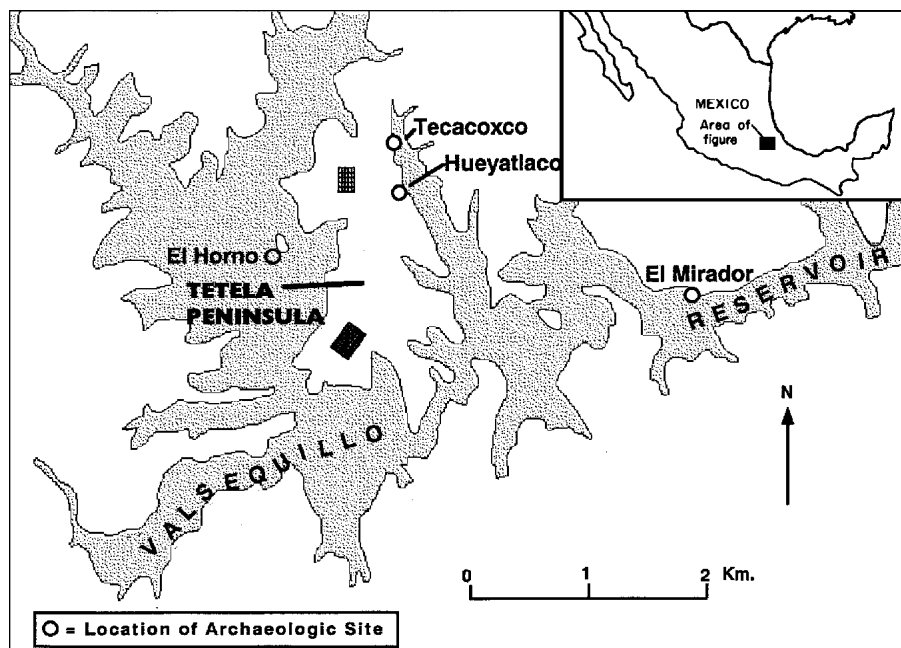

Map of the area. The sites discussed lie along the north shore of the Valsequillo Reservoir, south of the City of Puebla.





Mastodon phalange (toe bone) with deep cut encircling the base, found in the El Horno excavation. (Armenta, 1978, fig. 61-1)

## JEALOUSY AND ACCUSATION

Dating her sites was only one of Irwin-Williams' concerns during those years. She also had to contend with the insane jealousy of a highly placed archaeologist in Mexico City—a man who did all he could to discredit her, Armenta and their work.

In a series of moves that sound like a plot for a TV soap opera, they were accused in print of incompetence, with dark suggestions of worse things.<sup>4</sup> Massive excavations were made by a rival team of archaeologists only metres from her trenches.<sup>5</sup> Armenta's life-work was confiscated and moved up to Mexico City,<sup>6</sup> and he was forbidden by law to do any more fieldwork of any kind, ever.

Cynthia easily refuted the charges against them,<sup>7</sup> but it obviously was a difficult time for her, for Juan, for us all.

## "IMPOSSIBLE" URANIUM-SERIES DATES

Meanwhile, other scientists were also trying to date the site. In 1968 Barney Szabo, a geochemist with the United States Geological Survey (USGS), wanted to try the then-new radiometric method on the fossilised bones—the uranium-series method.

Cynthia sent Barney a molar from the butchered mastodon at El Horno, a pelvic bone from the butchered camel skeleton associated with bifacial tools at Hueyatlaco, and a bone associated with the one stone-flake scraper that made up her "site" at Caulapan. (Caulapan had already been dated at approx. 22,000 years by the <sup>14</sup>C method, using fossilised snail shells found next to the scraper.)

The dates came back.<sup>8</sup> Irwin-Williams was delighted with the ones for Caulapan: 22,000 ± 2,000 years by one U-series ratio; 20,000 ± 1,500 years by the other. They agreed closely with the <sup>14</sup>C date on the fossilised snail shells: 21,850 ± 850 years.

But oh, the other dates!

The butchered camel pelvis from Hueyatlaco dated 10 times older than the oldest date we had ever considered: greater than

180,000 years by the first ratio; 245,000 ± 40,000 years by the second. And the El Horno dates were even "worse": greater than 165,000 years by one ratio; *greater than 280,000 years* by the second!

Cynthia ignored these new dates, calling them "impossible".<sup>9</sup> She considered the 22,000-year <sup>14</sup>C date for Caulapan valid for her other Valsequillo sites as well—the *only* valid date.<sup>10</sup>

"Poor Barney!" the rest of us thought. "His methods only work on young material."

## PARADIGM SHIFT

Although the evidence for very ancient hunters was clear, we other scientists on the project had our politically correct blinders on. Since the sites "couldn't be that old", we assumed out of hand that something was wrong with Barney's methods—until we began to look more closely at the sites, especially the Hueyatlaco site, and at our own lack of results.

Hard to believe, but it took *seven years* of negative results at the microscope before my thinking began to change. What if Barney's dates were correct? If so, I would never find that elusive correlation I was looking for between a dated volcanic ash layer on La Malinche volcano and one of the undated ashes at the Hueyatlaco site. The matching layer I was seeking would, in reality, lie deeply buried in the flanks of the volcano, covered over with a quarter-million years' worth of younger deposits!

As I began to look at the problem with new eyes, it was obvious that, geologically speaking, the Hueyatlaco site was *old*. The sediments were all highly weathered. The volcanic glass was turning to clay. There were many buried soils in the overlying sediment pile, each one representing hundreds if not thousands of years when the landscape just sat there with little deposition or erosion. The sediment cap over the artifact-bearing layers was at least 10 metres thick and probably had been much thicker at one time. Erosion by the nearby river had cut down through that cap at least 50 metres.<sup>11</sup>

A *quarter-million* years? That meant that if we were ever going to date the site using other than the controversial uranium-series method, we would have to stop thinking "New World" with its comfortable <sup>14</sup>C dates and start thinking "Africa". Only in Africa, with the early hominid research going on there, would we find the means to date such old archaeological material.



Mandible (jawbone) from a mammoth skeleton discovered by Armenta near the small hamlet of Arenillas, north shore, Valsequillo Reservoir. Protruding from the bone is a flint spearpoint. Inset: Another view of the spearpoint in place, showing the damage it caused to the bone. (Photos from Armenta estate collection)

## ELATION OVER ZIRCON FISSION-TRACK DATES

Fortunately, the scientists working in Africa had faced a similar problem to ours and had come up with several radiometric dating methods besides the unsuitable <sup>14</sup>C method. And most of those methods required volcanic ash!

In 1973, early sites in Africa were commonly dated radiometrically using materials from overlying volcanic layers. The potassium-argon method was popular, but it required lava flows and/or potassium-rich mineral crystals. We had neither at Hueyatlaco.

But we did have tiny zircon crystals (very tiny, about the size of a grain of sugar) in the tephra samples. This meant we could use the zircon fission-track dating method on the younger volcanic ash and pumice layers exposed in the archaeological trenches.

Dates for these tephra units would give a minimum age for the underlying, older artifact beds.

In 1973 Chuck Naeser, another geochemist with the USGS, offered to run the zircons for us. We didn't ask him for precise data at the time, as that would have required weeks of hard labour. We only wanted "the big picture": to know if his zircon dates would fall closer to Barney's "impossible" 250,000-year uranium-series dates or to Cynthia's "politically correct" 22,000-year date.

The dates came back with two sigma numbers—meaning that statistically there is a 95 per cent possibility that the actual measured date falls within the stated range. Even with a large plus or minus value, Chuck's dates agreed with Barney's: 600,000 ± 340,000 years for zircons from an overlying pumice-rich mudflow layer; 370,000 ± 200,000 years from an overlying air-fall ash layer.<sup>12</sup> Cynthia's wishful-thinking date of 22,000 years was out of the running.

I was elated! Several lines of geologic evidence, including six radiometric dates, placed big-game hunters in Mexico a quarter-million years ago. As far as I was concerned, it was an open-and-shut case.

How naïve I was!

## ESTABLISHMENT DENIAL

It was the geologists versus the anthropologists; fact versus theory. Geologic evidence said the Valsequillo sites were *old*. Entrenched theory said the sites were *young*.

In a classic case of argu-

ing from theory to fact, then throwing out the facts that don't fit, Cynthia Irwin-Williams wrote:

"These [bifacial] tools surely were not in use at Valsequillo more than 200,000 years before the date generally accepted for development of analogous tools in the Old World, nor indeed more than 150,000 years before the appearance of *Homo sapiens*."<sup>13</sup>

Privately, she referred to those of us involved with dating the site as "the lunatic fringe".<sup>14</sup> She ceased all communication with us from that time forward.

## PUBLICATION WOES

If this were a perfect world, the Valsequillo players would have

sat down at the same table and debated the issues publicly until the truth came out. But it isn't. And we didn't.

Cynthia Irwin-Williams was an establishment anthropologist with degrees from prestigious schools and influential friends in the east. I was a geologist with a PhD from a small western university and my dad was a meat cutter. Her friends, especially her men-

tor H. Marie Wormington, advised her to ignore me and the whole geological thing and preach the 22,000-year date for *all* her sites. And she did.<sup>15</sup>

Meanwhile, we geologists were having a hard time getting our old dates for the sites into print. We started out well with an exciting news release in the fall of 1973. The story was picked up by the wire services and quickly circled the globe. But then, when it came to the critical research paper, it was one delay after another.

From 1975 to 1979 we waited for the paper to be printed in a scientific book. After four years, the third editor decided not to publish the book at all. The manuscript was returned.

In 1980 I submitted the paper to the editor of a popular science magazine who had requested it. After several months' delay, he regretted that "the manuscript had fallen down behind the file cabinet and had been lost". It was returned.

By 1980 my career as a research geologist was suffering. My professional correspondence, both



Overview of the Hueyatlaco site in 1973 during excavation to expose the sedimentary layers and to collect samples for zircon fission-track dating. The artifact-bearing beds appear at lower left; the volcanic ash and pumice layers occur in the overlying (younger) sediment cap, visible at middle and upper right. (Photo by Hal Malde)

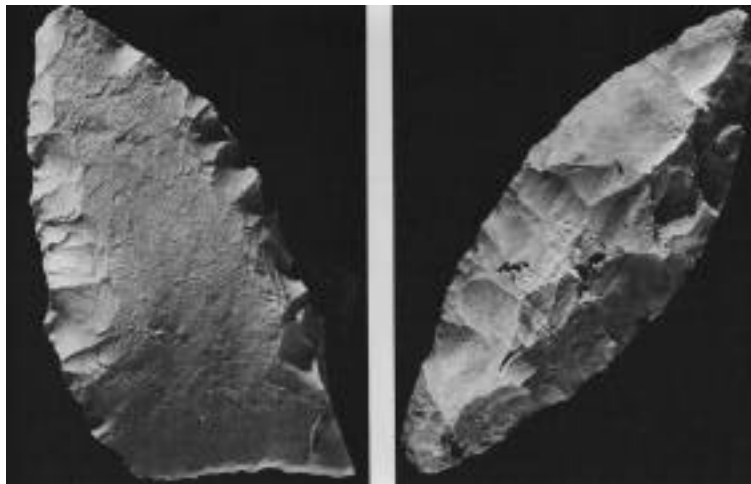

Representative artifacts from Hueyatlaco. Left: edge-retouched tool. Right: bifacial tool. The edge-retouched tool is older. (Photos by H. S. Rice: Irwin-Williams estate)

domestic and foreign, fell to near zero. My government job disappeared. My contract as an adjunct professor at one of the state universities was subsequently dropped. And were my geological colleagues avoiding me?

You couldn't blame them, really. In 1973 we geologists made a startling announcement: we had found evidence for mammoth hunters in Mexico 250,000 years ago. Seven years later, no supporting data were forthcoming. Where were the facts? Were the dates wrong? Were we wrong? Why no information? My future as a professional scientist looked grim.

I then submitted the manuscript to an acquaintance of mine: geologist Steve Porter, editor of the high-powered scientific journal *Quaternary Research*. Steve was a gem. He wrote that he did not care how controversial our findings were as long as we had the scientific data to back them up. He sent the article out to other scientists for review. It was approved, accepted for publication and finally saw print in 1981.<sup>16</sup>

But it was too late. That 22,000-year date for *all* the Valsequillo sites, including Hueyatlatco, had flooded the literature and was now set in concrete.<sup>17</sup>

So there I was in 1981: stonewalled, jobless, no career, damaged reputation, mightily depressed. For 13 years I dropped out of science completely. During that time, Armenta, Irwin-Williams, Wormington and the jealous archaeologist died; Malde and Szabo retired; and I cared for elderly relatives and became a professional flower gardener.

## A NEW START, BUT THE SAGA CONTINUES

Then things began to turn around.

In 1993, Cremona and Thompson's book, *Forbidden Archeology*, was published. Eight years in the writing, it has a nice section on Hueyatlatco and my problems with it.

In 1994 I did a short segment for the *Sightings* TV program, and in 1996 did a larger segment for the network special, *The Mysterious Origins of Man*.

In 1997 I gave my first lecture on Hueyatlatco in over 20 years, did a bit of fieldwork in Mexico and examined the late Irwin-Williams' files. (Her critical Valsequillo materials have disappeared, as has most of my correspondence with her.) A wealthy philanthropist became interested in the project and we sent away material for more radiometric dates.

In July 1997, I "just happened" to learn that primitive human skull fragments are coming to light in Valsequillo-like sediments west of Mexico City. According to entrenched theory, those fragments can't be there. Establishment scientists are involved. They are trying to date the fragments using the <sup>14</sup>C method. I told them to try the uranium-series method instead, and not to forget all the work we've already done at Hueyatlatco.

In March 1998, in response to news about the well-documented Monte Verde site in Chile,<sup>18</sup> establishment archaeologists at the 63rd Annual Meeting of the Society for American Archeology admitted that humans just may have entered the New World earlier than they thought—perhaps as long ago as...15,000 years!

Things are getting interesting. Stay tuned in!



Scribed fragment of mastodon pelvis, showing a four-tusked mastodon and other animals. The bone was worked while it was still fresh. It was found in the 1950s, weathering from Valsequillo sediments 50 metres north of what later would be the main excavation trenches at Hueyatlatco.

(Photo by D. Hiser; sketch by Armenta: Armenta estate collection)

### Endnotes

1. Szabo, B. J., H. E. Malde and C. Irwin-Williams (1969), "Dilemma posed by uranium-series dates on archaeologically significant bones from Valsequillo, Puebla, Mexico", *Earth and Planetary Science Letters* 6(4):237-244.
2. Steen-McIntyre, V., R. Fryxell and H. E. Malde (1981), "Geologic evidence for age of deposits at Hueyatlatco archeological site, Valsequillo, Mexico", *Quaternary Research* 16:1-17.
3. Armenta Camacho, J. (1978), "Vestigios de labor humana en huesos de animales extintos de Valsequillo, Puebla, Mexico", *Consejo Editorial del Gobierno del Estado de Puebla*, Puebla, Mexico, p. 11 (128 pp; published privately).
4. Lorenzo, J. L. (1967), "Sobre Métodos Arqueológicos", *Boletín del Instituto Nacional de Antropología e Historia*, Mexico City, Junio 1967, pp. 48-51.
5. Irwin-Williams, C. (1967), "Comments on Allegations by J. L. Lorenzo Concerning Archaeological Research at Valsequillo, Puebla", Miscellaneous Publications, Paleoindian Institute, Eastern New Mexico University, Portales, NM, USA, p. 2 (7 pp.).
6. Armenta Camacho (1978), op. cit., p. 120.
- 7a. Irwin-Williams, C. (1967), op. cit.

- 7b. Irwin-Williams, C. (1969), "Comments on the associations of archaeological materials and extinct fauna in the Valsequillo region, Puebla, Mexico", *American Antiquity* 34(1):82-83.
8. Szabo, B. J. et al. (1969), op. cit., p. 241.
9. Ibid.
10. Irwin-Williams, C. (1978), "Summary of archaeological evidence from the Valsequillo region, Puebla, Mexico", in Browman, D. L. (ed.), *Cultural Continuity in Mesoamerica*, Mouton, The Hague, Paris, pp. 7-22.
- 11a. Steen-McIntyre, V., R. Fryxell and H. E. Malde (1981), op. cit.
- 11b. Cornwall, I. W. (1971), "Geology and Early Man in Central Mexico", *Proc. Geologists Assoc.*, vol. 82, part 3, pp. 379-392 (p. 388 and fig. 3), and cited references.
12. Steen-McIntyre et al. (1981), op. cit., table 2.
13. Szabo, B. J. et al. (1969), op. cit., p. 241.
14. Cremona, M. A. and R. L. Thompson, *Forbidden Archeology*, Bhaktivedanta Institute, Govardhan Hill Publishing (PO Box 52-211, Badger, CA 93603 USA), 1993, p. 366 (914 pp); condensed edition: *The Hidden History of the Human Race*, 1994 (322 pp.).
15. Irwin-Williams, C. (1978), *ibid.*, pp. 18-20.

16. Steen-McIntyre, V. et al. (1981), op. cit.
- 17a. Lorenzo, J. L. (1978), "Early Man Research in the American Hemisphere: appraisal and perspectives", in Bryan, A. L. (ed.), *Early Man in America from a Circum-Pacific Perspective*, Occasional Papers No. 1, Department of Anthropology, University of Alberta, Arch. Res. Inst., Edmonton, Alberta, Canada, pp. 1-9 (fig. 1, p. 4).
- 17b. Canby, T. Y. (1979), "The Search for the First Americans", *National Geographic* 156(3):330-363, September 1979 (pp. 350, 352, 354).
- 17c. Bryant Jr, V. M. (1992), "In Search of the First Americans", *1993 Yearbook of Science and the Future*, Encyclopaedia Britannica, Inc., Chicago, pp. 8-27 (pp. 19, 24).
18. Meltzer, D. J. (1997), "Monte Verde and the Pleistocene Peopling of the Americas", *Science* 276:754-755, and references.

### About the Author

Dr Virginia Steen-McIntyre is a geologist who specialises in the study of volcanic ash layers, especially those used to date ancient archaeological sites. At present she is not gainfully employed. She and her husband live in a small mountain community west of Denver, Colorado.





## REVELATIONS OF A REFUGEE FROM 1999

The following three letters were recently faxed to US radio talk show host Art Bell by someone who claims to be a time traveller. He makes some startling revelations for the next few years based on what he's seen in his journeys into the near future, and the past. While it is obviously difficult to judge the veracity of the content, we thought these letters worth publishing for what they suggest about time travel *per se*, and so we can all compare notes on what happens in the next couple of years!

Incidentally, Art Bell received these letters successively on 26 February, 3 April and 9 April 1998, but the last message should have been the second one to arrive! We now reprint them with slightly edited spelling and punctuation. Anyone wishing to see the original versions can visit Art Bell's website <[www.artbell.com](http://www.artbell.com)>.

### 1) Received 26 February 1998

Mr Bell,

I am a Time Traveller. Please, you *must* read on!

If you read any of this over the air, do not read the following:

You or Keith, your web guy (I am sorry that I do not know which of you it will be),

will soon be receiving an anonymous e-mail (it will be completely untraceable). Files attached to a short note will explain that the contents are images of photocopies of three very important documents: two will carry the United States Pentagon Seal and the other will contain a seal of the Royal Air Force of the United Kingdom.

Before I continue, I must stress that *lives* are on the line here. This is an important issue. I know that what I am about to reveal will sound totally ridiculous. I also know that you must be the recipient of many a hoax. I assure you that this is *no hoax*. You, of course, will have this proven to you by the receipt of the said e-mail and by the coming to pass of the information I will reveal later in this letter.

The copies of the US and UK documents, my good sir, I am certain will both frighten and delight you. They are not fictitious. They describe

the transfer of a downed UFO from the United Kingdom to the United States in November of 1994. In actuality, the first US document is a copy of a letter, written as a complaint to the RAF concerning damage to the triangular UFO during its transport. The other two are follow-up letters which are included to confirm the topic of the first.

These must not be posted on your website or mentioned on your two radio pro-

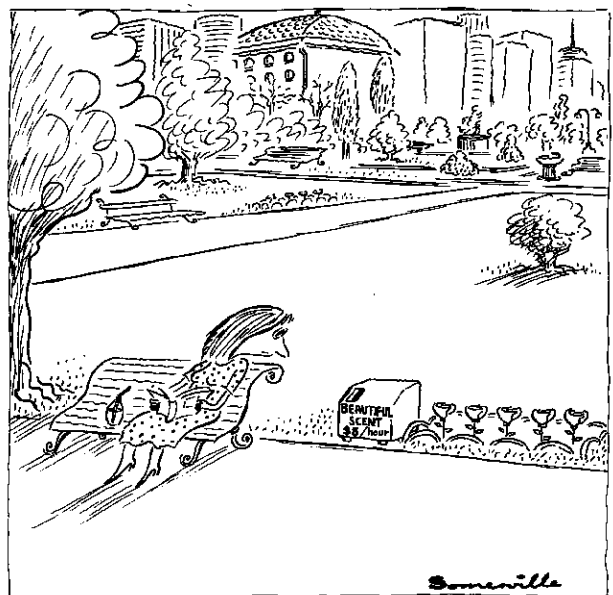

# THE TWILIGHT ZONE

grams until after September 12, 1998. Lives will end if you can not, or choose not, to heed this warning! Failure to heed this warning will result in catastrophic events culminating in the possible deaths of *thousands* of men, women and children.

If you wish, you may read the remaining portion of this letter over the air.

As I have stated, I am a Time Traveller, although we refer to it as "riding the wave". I am a US citizen, born in 1964. I am nearly 40 years old. In 1983 I enlisted in the United States Army. It was shortly after my enlistment and before completing basic training that I was first approached by those I now refer to simply as "My Friends". This group does not consist of aliens nor interdimensional beings: they are human.

I have learned over the years that not everyone can safely travel the wave, and I was first approached, I was told, due to an unusually large amount of some chemical that naturally occurs in the human body. It somehow aids in the time travel process. (My Friends told me what chemical it was back then, but that was many years ago and I have long since forgotten the name of the stuff. I think it has some copper or something in it.) I have since learned that when I enlisted in the US Army, My Friends gained a large amount of informa-

tion about me, my genetic history and so forth, and it was this information that changed my life forever.

I have travelled the wave 16 times on various missions for My Friends, but five days ago, while I was back in 1999, I stumbled across some information I wish I never had! My life is no longer guaranteed, and I find that My Friends are far from true! The information proves that My Friends are members of an organisation that I see referred to only as "The Club". I have no doubt, however, that this group is in fact the same group that others have called "MJ-12", etc.

I am now a fugitive. I was arrested and began to see that I was to be killed, so I escaped from My Friends two days ago, June 21, 1999. Before I rode the wave back to 1998, I prepared a packet of information, including names, dates and even some photographs. I have arranged with a friend for this packet to be forwarded to you and a few others in the event of my untimely death or disappearance. Please keep in mind that this packet was left with a very trustworthy individual two days ago, June 21, 1999. As I have now disappeared, I am confident that the packet will find its way into your hands.

I will not remain in 1998. I took the chance to rest here so that I could pass on this vital information and also take care of some personal duties. I will not reveal in what time period I intend to arrive, but I will, on occasion, check back into this time period.

To aid in proving the veracity of the information I have revealed to you in this letter, I will now reveal a few things further (I am keeping back

a few things that I do [not] think it is now wise to reveal):

1) President Clinton will pass through this current scandal and the next as well. (Look for the words "Hollow Oaks" to be associated with the next scandal.)

2) President Clinton will not finish his second term; he will resign due to health problems soon after the Hollow Oaks scandal. President Gore will lead his rejuvenated Democratic Party as well as the nation to bringing not one but two new states into the union.

3) A man named Brown will appear to be a strong candidate for the Republican presidential nomination to run against President Gore; however, the ticket in 2000 will be Quayle/Bush.

4) "It is far better to live in a world where Saddam is in power in Iraq." Watch for this quote to appear as a headline in the *Washington Post*—you will not believe who said this.

Just a few more quick notes:

1) Time travel need not be achieved solely by mechanical means. I use only a small electromagnetic tuner, and my developed abilities, to ride the wave with ease.

2) I have been sent on 16 missions for My Friends over the years. The packet I mentioned above contains the logbook that I secretly kept while on these missions.

3) It is unbelievably difficult to create the feared "time paradox". On my second mission we tried to create the paradox; we could not. Time is like a river, ever flowing and changing but always moving forward.

4) I was a big fan of your late-night TV talkshow (I have several on RDVD!).

Mr Bell, I hope never to have to contact you again. When you get my packet, I trust that you will do what needs to be done. This may be a bit of a cop-out on my part, but I deserve a normal life. I can no longer be a part of this. May God forgive me if I am making a mistake, but I am going to try to lose myself in my chosen time. If I am successful, I will live and die a normal life.

May God bless you in the upcoming times.

— A refugee from 1999

## 2) Received 3 April 1998

Mr Bell,

I am the Wave Rider who has contacted you previously.

I will be dead in less than two years.



This is a fact I have confirmed through time travel. This is why I am now convinced that I must expose ~~My Friends~~ My Enemies for the butchers that they truly are.

If you read any of this over the air, do not read the following. [Section deleted by Art Bell.]

You may read the following on air if you so choose:

In my timeline, this is the third time I have chosen to contact you. I have news to report to you that I trust will find its way to your listeners. Firstly, I have successfully stopped the transmission of the documents (letters via e-mail) that I mentioned only to you in my first letter. Secondly, I have names and dates and other information which I have only recently obtained. Thirdly, I fully intend to turn these items and many others over to you just as soon as I am certain that I can do so without causing the deaths of others.

You may not yet have received my second communication. I am uncertain of the date on which I sent it to you; however, in it I explained to you why I felt it was important not to reveal more about myself, my abilities, My Enemies or their organisation. However, due to the actions of My Enemies, described in brief below, I have changed my mind. To this end, I will slowly release information as I feel it proper and timely to do so.

Why have I changed my mind? Allow me to relate the last 12 months of my life in short:

It has been almost one year since I first contacted you. I had chosen to live in the United States in the early 1950s. I was nearly captured by a fellow Wave Rider; I spotted her before she found me. I assume she must have been sent to track me down. She did not spot me and I left that time period as quickly as I was able.

I then attempted to live quietly in England circa 1945. My hopes were that, with all the troubles of World War II still being sorted out, I might just get myself lost in the confusion of post-war Europe. After almost eight months without incident, I began to feel safe. It was at this time that I returned to your time period and sent you my second communiqué. I even found myself a lady friend with whom I finally started to live the normal life I so much desire. In January of 1947 I came close to losing my life, and my darling Clare lost hers as we attempted to escape.

I was forced to kill another human being—may the God of my fathers forgive me. I took his life, fuelled by hatred at the murder he, under the orders of My Enemies, had committed, and now, can I be any better than he? No, I am not, but perhaps I can in some small way redeem myself. At least I know that I may prevent further deaths.

I should first explain how I travel in time. The short and sweet of it is that I was taught to target a particular person, place or event. The more information I have on the target, the better my chance of success and the faster I reach my target. I take a photo of the target, a sheet of paper with the information written on it, a map of the site, etc. I circle the target and begin the process. I then enter a quiet, darkened area (we used to call it "the pad"). A period of concentration and meditation then begins. For days, weeks and sometimes even months after beginning, I will study the target, concentrate on the target, even begin to dress in the period clothing of the target during my time in the pad (only about two hours per day is all I can manage). As I begin to feel the wave approaching, I look for the doorway, the gateway, the rip in the fabric of time or whatever you want to call it. For me, it almost always looks like a pool of water that I pass through before entering the new timeline.

Some Time Travellers had only out-of-body type experiences (these people we

call Projectors); others of us (called Wave Riders) physically disappeared from the current timeline. Early on in the project, I would use a small electromagnetic tuner to help me concentrate and focus on the target. I no longer use any aid when wave riding.

I told you in my first fax that I have travelled back in time on 16 occasions. Truth to tell, I was sent on 16 *official* missions. I also travelled back on two not-so-official occasions for certain very powerful men. Also, I have travelled back many times on my own. (This is what really got me into trouble!) On every occasion I kept a diary of my—for lack of a better word, what I will call—adventures. I plan to release this diary as well.

Reading the newspapers in this time period for your last few days, I find that I have returned to your timeline just as one of President Clinton's scandals has cleared. You will soon see, as I stated when I first contacted you, that this will be the trend: he will continue to be cleared over and over again. However, the roots of the "Hollow Oaks" scandal have also now been laid. This President should not finish his second term: the claim of health trouble will force him to resign in his eighth year. Not long after leaving the White House, Mrs Clinton will file for divorce; she will leave the country and later marry an oil executive from Mexico. The couple will live quietly in Mexico and she will author numerous books such as *The White*

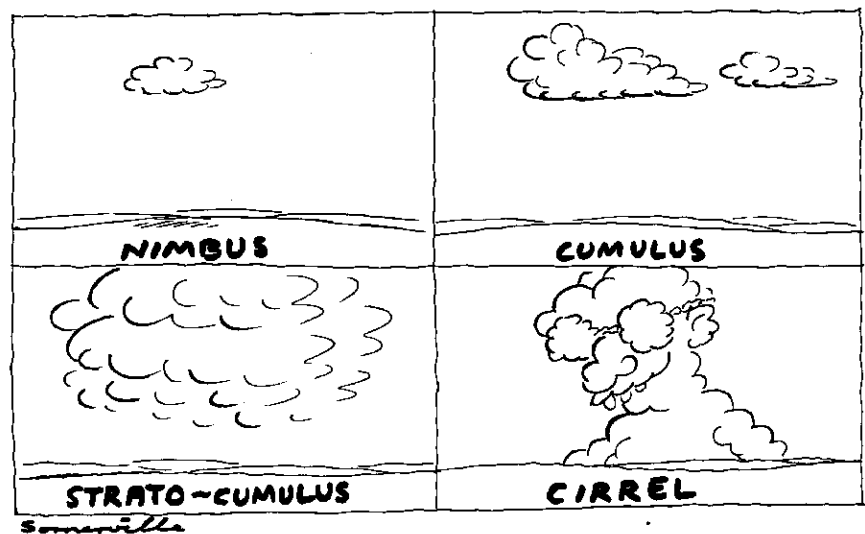

# THE TWILIGHT ZONE

*House Hush, Life Without ~~Bull~~ Bill* and others.

You also have not heard the last of Saddam. He will be involved in an Islamic/Israeli war in which Russia will also be involved. (This before the year 2000!) The United States will continue to decline in power and influence, just as the States of Europe will increase in power and influence.

Mr Bell, I pray you will be willing to assist in my efforts to release the truth. I ask your assistance in bringing more of my story to the public. I await your reply. I will be listening, sir.

— A refugee in time

### 3) Received 9 April 1998

Mr Bell,

I am the Time Traveller who faxed you some time ago.

Do not read the following over the air. [Line(s) deleted by Art Bell.]

The following need not be kept confidential:

I thought, or at least hoped, that I would never contact you again. I have chosen to communicate with you this second time just to assure you that I am alive and well, and I believe that I will be left alone to live out my life in quiet obscurity.

When I first departed 1998 after contacting you, I had determined to live in 1952 Iowa. Just eight days after my arrival I looked into renting a house. I was not able to do so, but I was told about a small house

in a nearby town that was for sale. I left to go visit the town and see the house. I took the bus. When we pulled into town I spotted a woman I recognised as a fellow Wave Rider. Suspecting that she must have been sent to track me down and kill me, I got off the bus, purchased a ticket to another city and started preparing to ride the wave to my next choice of times in which I wanted to live.

It has been months since that happened, and, as I now reflect on things, I believe that she was most probably sent back to offer me a chance to lose myself permanently, provided that I never revealed what I know. (This offer was made to another person who had to leave the project in the early '90s.)

I am pleased to say that I have found the love of my life, and, although I will do nothing to further reveal more than I already have, I do hope that you will, when you receive my packet of information, release what information you deem appropriate. You will receive the information packet soon. I encourage *you* to make public the information it contains. I will not, can not, risk losing all that I have found, but I still believe that the information must be made public.

I recall some years ago hearing you say that you believed that the so-called "Magic 12" or "Majestic 12" secret government within our government was no myth and that they were a truly powerful entity. As I recall, you were doing a program that was

more or less a final tribute to Robert O. Dean. He had died on the day before and you rebroadcast an interview you had with him, examined some of his work and praised his contribution to the cause. When the interview finished you began to explain how you, too, believed in the "MJ-12" group. I tell you without doubt that I also believe this group exists. Further, I believe that the organisation that I call "My Friends", and that they themselves call "The Club", is one and the same group.

I am confident now that I have successfully lost myself in the past, and I feel that the only thing I did not put into my packet of information that I should also reveal is that The Club is not merely an American group. This is an international and extremely well-connected group of men. Further, many of the more powerful members are actually members of the industrial wealth of Europe and Asia (China and the former East Berlin [Germany] are well represented, as is Japan).

I am going to risk one final ride to 1999. The reckless release of UFO information I revealed in my first fax preys on my [conscience]. I must make an attempt to get the documents myself, before it can be uncovered. If this information was only being sent to you, I would not worry; but I believe the information is being sent to other persons as well as yourself. I can not trust that these others would be willing to sit on it until after September 12, 1998. If you recall, the information I am referring to concerns the transportation of a triangular shaped UFO from the United Kingdom to the United States. I must obtain these documents before they are uncovered and sent to you and others. (If successful, I will post the information to you after September 12, 1998.)

Watch the mail for my packet, and I trust you to do the right thing.

I wish only to say that I admire you and the work that you do now and will do in the future. You will be so much more than you currently imagine. You have been a lone voice of truth and reason crying out to me from the desert. I thank you for setting an example and, by that example, helping me decide to do what I now know had to be done. You will never know just how much you have meant to me. Thank you, sir.

— A refugee in time, and, as always,  
a fan

(Source: Art Bell, [www.artbell.com](http://www.artbell.com))









# UFOs & EBEs

## MORE INSIDER EVIDENCE

*This testimony from a former US Army Signal Corps and CIA officer is the latest to confirm that the US government and military are withholding the facts about extraterrestrial craft and biological entities.*

by Linda Moulton Howe © 1998

LMH Productions  
PO Box 300  
Jamison, PA 18929-0300, USA  
Telephone: (215) 491 9840  
Fax: +1 (215) 491 9842  
E-mail: LMH333@AOL.com

Since my new book, *Glimpses of Other Realities—Volume II: High Strangeness*, was released to nationwide US bookstores on April 1, 1998, I have heard from several ex-military and ex-intelligence people from around the country. They say the documents and military voices in my new book have true information about United States Government knowledge and cover-up of non-humans interacting with Earth.

And a month ago, in May, I was put in phone contact with a man I will simply call "Kewper" to protect his identity at his request. Kewper served as a First Lieutenant with the US Army Signal Corps and was a CIA administrator at an Army base in the southeastern USA from 1957 to 1960. He provided his DD-214 and Certificate of Discharge along with a 1956 newspaper article about his being drafted. That civilian name and Army Signal Corps base of operations were consistent with the Army discharge papers.

I would name the Army base, but as you read further you will see that Kewper was asked by a government watchdog to withhold that information in order to protect current CIA-sensitive and classified operations out of the same base in 1998.

Back in the 1957 to 1960 period, Kewper taught radio operations and cryptography to Army Signal Corps officers under a false identification assigned to him by the CIA. The head of that Signal Corps school had worked for the Office of Strategic Services (OSS) during World War II. The OSS became the Central Intelligence Agency in 1947. In addition to teaching, Kewper's CIA boss at the Army base asked Kewper to help analyse Top Secret cases gathered for the Air Force's Project *Blue Book* investigation of unidentified flying objects.

When I first talked with Kewper a month ago, he said his security oaths expired 30 to 35 years after he got out of the Army and CIA in 1960. So that period ended around 1995. Therefore, he said, he now feels he's not doing anything wrong by discussing with me his extraordinary first-hand knowledge and experiences concerning "extraterrestrials"—as he said they were referred to in the Top Secret classified files he'd read and analysed. However, a month ago he was not certain he wanted to go on the public record.

On Saturday, May 30, I called him again to ask if he might now be willing to do a radio interview as long as his real civilian name was withheld. Since 1993 I have been reporting science and environmental news for the nationally syndicated Chancellor Radio Broadcasting Network. Kewper surprised me when he immediately said, "I'm afraid your phone is tapped." He'd had a call on Monday, May 25 from a man who did not explain who he was or for whom he worked, and did not address Kewper by name but simply started talking. And this is what Kewper told me on the record, under the condition that I edit out subjects that the unidentified caller said were still sensitive. Those edits are indicated by parenthesis notes in the following interview first broadcast on the North American syndicated radio programs *Dreamland*, on May 31, 1998, and *Coast to Coast AM Hosted by Art Bell* on all-night radio, June 1-2, 1998:

**Howe:** You answered the phone and they said...?

**Kewper:** Yeah, they didn't repeat my name. They just said: "We understand that you had a conversation with somebody in Pennsylvania in regards to classified materials that had been classified, and we would appreciate it if you didn't bring up the fact in an interview or television interviews in regards to [Army base name deleted] that you had mentioned on the telephone, and also about anything going on in the [CIA aerial logistics deleted] or anything in regard to that. We would really appreciate it because reporters and just interested people, if it gets aired, may try to get into the classified area there—and, of course, to their own physical harm."

**Howe:** They did not say that you could not talk about the six-fingered humanoid film?

**Kewper:** No; nothing like that.

**Howe:** Well, then, could we do an interview today? Not for name attribution but to put you on the radio as a person who served—and you can tell me how you want it described—and who saw this film, and you could try to give me the year. Can we do that?

**Kewper:** Yeah, I guess so, as long as I don't bring up anything about...

**Howe:** So you were getting the reports that Project *Blue Book* was collecting; that they were allowing to the public only those they were explaining. You were actually handling the files that were unexplained?

**Kewper:** Yes. Probably not all of them, but at least we were one of the groups investigating the unexplained. I know when they closed down Project *Blue Book* they said they had found absolutely nothing as far as what they did in Project *Blue Book* that wasn't explained. And that was actually true because anything they didn't explain would be sent to Fort Belvoir in Virginia and then farmed out from there to other military. The FBI was involved with some of the things, too, I know, because FBI would show up on some of these peoples' doorsteps.

**Howe:** What were the years that you were personally working in the CIA and handling these highly classified reports related to the UFO phenomenon?

**Kewper:** 1957 to 1960. I was in the service starting in 1956, but I didn't get involved with this in the first year, you know.

**Howe:** And your rank was what and in which military branch?

**Kewper:** I was in the Army and a First Lieutenant. I was still actually in the Army Signal Corps, but I also worked for the CIA, too, because I was getting two paychecks. I was getting one from the CIA and one from military service.

**Howe:** Now, in the course of this work from 1957 to 1960, did you see any 16-mm films related to this phenomenon?

**Kewper:** In regard to UFOs in Roswell, you mean?

**Howe:** Right.

**Kewper:** The only film I saw is the one that has been released in the last couple of years showing an alien autopsy. I saw that very same film in 1957.

**Howe:** And what were the circumstances in which you saw this?

**Kewper:** It was in regard to studying UFOs, in working up and going through and trying to cover or investigate some of these folders we had in regard to the different sightings. Apparently someone at Fort Belvoir, Virginia, sent that film to my boss. The team viewed the thing one Saturday morning and he had to send it right back to Fort Belvoir again. But we did see that one. And we also saw several other at that time highly classified UFO sightings on film. We had one film showing a UFO actually developing or materialising over a power plant out in one of the western

states like Oregon or Washington or Utah—somewhere out in that area.

**Howe:** You mean someone just happened to be filming?

**Kewper:** Yes. Someone was trying a brand new camera and they were filming this power plant. First, the mountainous areas around, and then they were over to this power plant. The power plant had a smokestack and had some smoke going on up. And a little ways away from where the smoke was going up, we started seeing little white, round...like a little piece of a cloud. It got more and more dense, and more and more round. And pretty soon you could see little tiny windows around the bottom section. I'm just using "windows" as a term loosely. It developed more and more, and pretty soon it looked real silver, and soon it started flying off by itself, slowly.

**Howe:** So you had on film, in Central Intelligence Agency work, we'll call it an actual materialisation of what appeared to be a hard, silver disc that literally just emerged from what looked like a vaporous cloud?

**Kewper:** Yes; just a little ways from a cloud emitted by the smokestack. So we thought at that time that these aliens must have some way of materialising or travelling from one area to another and materialising, by using the current that was down in the power plant somehow to change the electric currents...into something electromagnetic or something solid, like solid material.

**Howe:** Now, how was the autopsy/dissection of the six-fingered humanoid film presented to you? What was the explanation of how this had occurred?

**Kewper:** They just said that this was done at Roswell, the same day or day after—the same, I think—the craft was picked up at night; that some time during the next day this autopsy was performed there at the military base, and also an autopsy was performed in town in the little clinic or hospital they have there.

**Howe:** Now that would contradict the statement released with the autopsy/dissection film by the alleged cameraman who said he was there and filmed the wreckage and the beams that had the symbols, and that about two

weeks later, I believe, he was asked to go to some place to film the autopsy dissection. Do you know how to reconcile these two pieces of information?

**Kewper:** No, I don't, because we were told—it mentioned right in the film—that it was done in New Mexico, that most of the film was done right there at the military base outside of Roswell and that some little parts of the film were done at the local hospital or clinic.

**Howe:** And what was the briefing to you about these six-fingered humanoids? How were they described? Was there any information?

**Kewper:** There was little info in regards to that. The film was about 10 years old at that time, and they just said this was the only film that we have of the aliens and the body. There are pictures that have been taken by different private people showing these aliens walking around outside their craft, something like that, but this is the only film that we have that shows a close picture of the

So you had on film, in Central Intelligence Agency work, we'll call it an actual materialisation of what appeared to be a hard, silver disc that literally just emerged from what looked like a vaporous cloud?

aliens and exactly what they look like. So, if you run across any more of these sightings that people have sent in that describe this particular being, then you can match them up according to this.

**Howe:** Was the film you saw in black and white or colour?

**Kewper:** It was black and white.

**Howe:** And did you ever see any colour film or photographs of these beings?

**Kewper:** No, not of the beings. The only coloured film I remembered seeing was of that spaceship materialising.

**Howe:** Now, you were working for the CIA and this was tangential to Project *Blue Book*. How were you shown this film? What were the screening conditions? Were you in Washington? Were you in the South?

**Kewper:** Yeah, they sent this down to [location deleted at Kewper's request after anonymous phone call referenced in introduction to this interview] and we looked at the film. Then my boss had to send it right back the next day by a special courier they had running between Fort Belvoir and CIA headquarters.

**Howe:** How many of you were there?

**Kewper:** About 20 of us. There were 26 people involved altogether in our group, and I would say that about 20 of us saw it. Some were overseas at the time. A lot of the UFO pictures that

we got were not from the United States; they were European, Central American, Mexican, and South American sightings of UFOs. One was an Italian film. So I believe we got it down there at the CIA because the CIA had facilities in all these foreign countries to be able to try to verify some of these things; because we had men in all the different parts of the world.

**Howe:** So this was your first visual sort of experience with something non-human. Do you remember what you thought at the time?

**Kewper:** Yeah, I was kind of perplexed. I thought: How can this be? How can these beings come here? How can they be completely different from man?

**Howe:** But sort of resembled us in a humanoid-shape way.

**Kewper:** Yes, they did; they did resemble us. That particular alien, the six-fingered alien—you might say it didn't resemble us completely, but it looked like a miniature man with a smaller head, but it wasn't the great big narrow face with the big eyes. It didn't have ears like we have; it had a little circle around a hole inside of its skull. The ears didn't look like [ours]. The nose looked basically like [ours] and the mouth was much smaller.

**Howe:** Do you remember if this film was shown to you in 1957, 10 years after 1947? Was there any knowledge then among the intelligence agencies from any communication with these beings about what their origin was?

**Kewper:** Nothing really. While I was there, the whole three years, we never saw any information about where they came from and what they were doing here. Nothing was ever brought out in regards to that. My boss and I were both wondering about that: Why were they here? Why would they come here? And where were they from? During that period of time, as far as I know, the government had no idea where they were from or what they were trying to do here.

**Howe:** From a military and CIA point of view, were they considered a threat?

**Kewper:** Not really a threat, but there was a questionable

threat; and they were working under that assumption to try to increase the different radar around the country more so that they could detect if they were coming in from outer space and be able to get some type of scrambling from the Air Force's nearest base to check it out or shoot them down or whatever.

**Howe:** Were you ever given a briefing or exposed to any other information between 1957 and 1960 beyond that screening of the autopsy/dissection film?

**Kewper:** I would say no, not during that time. We just had the various foreign, a few domestic, but mostly foreign sightings that we had gone over. We had people overseas who would go and interview these people who had photographs of aliens outside of a saucer, but nothing at that time. Basically I saw just the film of the autopsy on that particular being; but, like I mentioned, when I went to Area 51 in 1958 I did see another type of a being where it was the peaked face, the great big eyes and the little chin that has always been termed a "grey", I believe.

**Howe:** Okay, can you describe that experience?

**Kewper:** We were out there for a meeting of all the CIA people around this country and over towards the Far East and so on, and we had the meeting there at Area 51. We were involved with this Project *Blue Book* thing and they wanted the meeting there, so

some of us involved directly with it—there were only five of us that went from [name of Army base deleted] and we were the only five that had the meeting out there. They had meetings right in the main buildings of the Air Force, a little base they had there.

**Howe:** At Nellis AFB in Nevada.

**Kewper:** Yes. But we went out to Groom Lake area and the two areas they had out there. They showed it to us, but only to us and not to the CIA people from the Far East or from Central America. They didn't go out there; it was only the

five of us. We landed at Area 51 at the main landing strip. Then we got into a van-type of small minibus. After that, we didn't stop to get into any other buildings there.

They took us down about 10 miles away, something of that nature, and stopped at the first special area. And they took us into the area there, and they had U-2s and also the SR-71 *Blackbirds*—I believe they were flying them at that time. We were there a short period of time, and then we got back on the bus and went about another eight miles to the third and final area where they had highly classified material. We stopped there and went into an office area first, and then a colonel there met us and took us on a tour. He took us first of all down a walkway into a hangar area that had been carved out. It might have been a natural cave to start out with, but at least it was carved out of the mountainside area. It was not extremely large.

**Howe:** Was this the Papoose mountain range?

**Kewper:** I wouldn't really know. I don't think I ever questioned what the mountains were.

**Howe:** Okay, but so I am clear, this is a colonel who is joining you and your CIA boss and three other CIA men in your program?

**Kewper:** Yes.

**Howe:** Were there only six of you?

**Kewper:** Yes. As we passed through different areas, naturally there were other workers and scientists working on different

While I was there, the whole three years, we never saw any information about where they came from and what they were doing here.

things, and office personnel.

**Howe:** And did you understand what the reason was that your boss was having you go to have this tour by this colonel?

**Kewper:** Yes. They wanted us to see the craft so when we looked at pictures, trying to identify fake pictures from the real thing, this would be a help to us. That was the main reason why we were toured through the area to see the different types of craft, so we could pick out the [hoaxed] "garbage can covers" from the real craft.

**Howe:** So the six of you, with the colonel, your CIA boss, yourself and these three other CIA men involved in this project, you're going, literally moving, walking into a carved-out area of a mountain?

**Kewper:** Yes.

**Howe:** Can you describe exactly what you saw?

**Kewper:** As soon as we got in, the first thing we did see were two small craft.

**Howe:** What colour were they?

**Kewper:** They were silver, kind of a silver finish to them; not real shiny and bright, but basically silver.

**Howe:** What was the diameter?

**Kewper:** About 18 or 20 feet. They were quite small.

**Howe:** Were you allowed to go over and touch them?

**Kewper:** No. We were on a walkway area and couldn't get down over to where the craft were actually sitting.

**Howe:** And how many others could you see?

**Kewper:** At least about seven, I think. There were some larger ones that were in the rear towards the end that we could see down there because they were probably 50 to 60 feet in diameter.

**Howe:** Could you see any characteristics on these? Were any different from another?

**Kewper:** They were all disc-shaped, but some had larger bottom areas that extended down the same as the top, the top extending up. And they were in different colours. The larger ones in the rear were a real deep, real dark grey colour, and some of the other ones were lighter in colour, but maybe like a light- or medium-brown type of thing. The larger ones in the rear had real large top units and large bottom units to them and were sitting on metal saw-horses to hold them up off the ground.

**Howe:** And did the colonel try to explain, or did he have knowledge or any understanding of the propulsion system of the extraterrestrial craft?

**Kewper:** That question was asked, and he mentioned it was electromagnetic/antigravitational-type engines. But some of the craft had other propulsion systems also, but he didn't go into great detail on other propulsions. Apparently it was like antimatter propulsion on one of the units, something of that nature.

And I saw they'd tried to reverse-engineer one craft, so part of it was taken apart. They were trying to figure out how it works, and he was explaining to us that there really was no physical motor in that thing. The entire disc was like an electronic circuit, and the aliens had to be inside of this disc to complete the electronic circuit to make it fly. The Area 51 people knew that, because they had tried to make that one fly. It was just like a battery electrical unit; it worked with antigravitational/electromagnetic drive, but

the whole saucer itself was like the drive of the ship. It was all coated with nickel inside and it was like a giant circuit, an electronic circuit. And it took the aliens to complete the circuit because they were tied right in with it: they had headbands they wore that had detectors on, and they had finger-type board control where they could fly the craft.

**Howe:** Those are the hand-imprinted, six-fingered control panels that were with that autopsy film?

**Kewper:** Yes.

**Howe:** And did you see the panels themselves actually there with the craft?

**Kewper:** Yes. They were there with the craft. They were trying to figure out the electronic circuitry because there was no wiring of any kind that they could see. But later on when they had it at Groom Lake, they had a couple of scientists there who used microscopes to check over the fingertip-control harnessing and found little fibres going out from it. They found out then that it was a fibre optic type of electrical transmission throughout the craft.

**Howe:** All done with light.

**Kewper:** Yes, it was light. The report I read originally said that when they looked inside the craft it was glowing with a real

thin light inside from all the circuitry fibre optics. Reverse-engineering of that is apparently where we got fibre optics from.

**Howe:** What was the colonel saying to you about these discs in relationship to where you were going next?

**Kewper:** He just stated that these are some of the craft we have picked up and captured in different parts of the world. Apparently some of them were even brought in from overseas from some point or other, but I gathered that most were captured within the US. He then mentioned that we

were going back out to the general office area and another smaller hangar area to see the being, this extraterrestrial being, that they had there at that time.

**Howe:** Try to walk us through what happened next.

**Kewper:** Okay. We went from the hangar area where the saucers were, out to a covered walkway area and into an office complex, I would call it, because it was a bunch of small rooms and offices. They had a special room for viewing that had one-way windows in it—one-way mirrors, rather. We could look through the window into this small office, and the being that was in there was not able to see us through the mirror because there was a mirror on his side.

**Howe:** And what happened?

**Kewper:** They said we could go in and talk to this being, and at that time I chose not to go in. Years later, I wished I had, but I chose not to go in because they did tell us that the being spoke telepathically. The colonel had more terms added to it other than telepathically, but the being wouldn't speak in any manner that we could hear through our ears. So I chose to stay out, and the other four people did go in.

**Howe:** Your boss, the three other CIA guys and the Colonel Jim?

**Kewper:** Yes.

**Howe:** Now, can you describe the being exactly, from your watching this and listening?

He just stated that these are some of the [alien] craft we have picked up and captured in different parts of the world.

**Kewper:** What the colonel called him was a "grey". He had the large head and bigger eyes, kind of slanted bigger eyes. He looked like he was wearing sunglasses because the lenses were real dark. He had kind of a slim face down to a peaked chin with just a little nose area, a tiny slit of a mouth and just holes in the side of his head for ear openings.

**Howe:** About how tall?

**Kewper:** About five feet, something like that.

**Howe:** What was the surface of the skin like in colour and texture?

**Kewper:** Yeah, it was greyish looking, but it looked fairly coarse, not like the smoothness of our skin.

**Howe:** Now what happened between your boss, the three CIA guys and Colonel Jim in that room communicating with the being?

**Kewper:** My boss did ask him, "What are you doing here? And why do you come here?" The only answer he got was, "We are not here to conquer the Earth. We are not here to destroy anything. We are here to add knowledge to humans so they can gain more knowledge in different areas."

He [the CIA boss] said it was probably like a 16- or 20-letter name where he was from, but he couldn't remember what the being said. After he came out and we left, I asked him and he said, "I don't remember what it was, but it was a real long name that he had given us as far as where he was from." He'd asked if it was a part of the galaxy or if that was his planet. He said the being answered back to him that it was part of a galaxy he was from. Not our galaxy, but a different galaxy.

**Howe:** A different galaxy?

**Kewper:** Yes.

**Howe:** When the being had "telepathed" to your boss that it wasn't here to hurt anything but to impart knowledge, how would they impart knowledge to us if they weren't making themselves public to the Earth in a straightforward way?

**Kewper:** I remember my boss mentioning that when he said that, he denoted the creature was stretching the truth or lying just by the tone of the answer, this type of thing; that he wasn't telling the truth altogether, you know.

**Howe:** Did your boss and the other men explain to you how the telepathic process went? What did they experience?

**Kewper:** They said they definitely weren't hearing a thing through their ears and that the voice they heard more or less was right in the mind itself. They could put their fingers in their ears and they would still hear the being. One tried that; he plugged both ears to see if he could still hear the being, and he could.

**Howe:** Oh, you could see through the glass that one of the men actually put his fingers in his ears?

**Kewper:** Yes, to see if he was actually hearing the being, and he wasn't, but he just heard what the being said right in his mind.

**Howe:** What was the sound of the being in his mind?

**Kewper:** He said the voice almost sounded like an electronically reproduced voice. And now, of course, we have computers that can talk to us and answer the phone with a computer voice.

Back in those days, that type of thing was just beginning with computers. He said it didn't sound like a human voice: it sounded like an electronic voice.

**Howe:** Neither male nor female?

**Kewper:** Neither one, sort of in between.

**Howe:** Why would the concept of a telepathic-communication being bother you?

**Kewper:** Well, naturally, it's something I'd never run across before; that would be a certain amount of bother, you know.

**Howe:** Did you ever learn in your work for the CIA what the relationship was between the six-fingered beings and the grey being?

**Kewper:** Nope, never did.

**Howe:** Did someone explain why this being was even being kept there?

**Kewper:** No. They wouldn't tell us why he was kept there, how long he had been there or anything like that. I think one of the answers was, "We can't talk about that." I believe that was the main answer.

**Howe:** And who at Area 51 seemed to be in control of this being? Which agency?

**Kewper:** It was the Air Force, actually. The Air Force colonel is the one we talked to.

**Howe:** Did this colonel or anybody explain to you what their perception was of this grey being from the standpoint of whether there was any kind of a threat?

**Kewper:** No, they didn't really consider it like a big threat, but there was always this: "We don't know for sure, but we don't think they are going to be harmful to us, but we don't really know for sure. We can't say for sure that they are not trying to invade, or checking us all out and checking out our military." Because even at that time, the saucer sightings were always around classified areas and any military bases, that type of thing. So it looked almost like they were scouting, you know.

**Howe:** By the time you left the Army Signal Corps and CIA in 1960, did you have any further briefings about the beings, and were they referred to as "extraterrestrials"?

**Kewper:** Yes, they were referred to as "extraterrestrials". Most of the time they referred to the one out there as a "grey".

**Howe:** The one at Area 51?

**Kewper:** Yes. They just referred to it as a "grey".

**Howe:** Did they have any live six-fingered humanoids anywhere?

**Kewper:** No, not that I know of. That was one of the questions I asked the military man on the way in there—if this was the same kind of being. He'd mentioned they had a being that we were going to look at, and I asked if it was the same being as Roswell. He said no. And I asked if they had any beings like at Roswell, and he said no.

**Howe:** And Roswell—from your point of view in 1957 when you were shown the six-fingered humanoid film, did it identify in the introduction where exactly the six-fingered humanoids had been retrieved from?

"We are not here to conquer the Earth. We are not here to destroy anything. We are here to add knowledge to humans so they can gain more knowledge in different areas."

**Kewper:** They just said "near Roswell".

**Howe:** But they didn't specify?

**Kewper:** No, no. They didn't specify if that was the craft they had captured near Roswell; they didn't specify that. They just said "near Roswell", and I understand they had two or three craft they had picked up there that same summer of 1947.

**Howe:** Did anyone talk about the weather balloon story as being deliberately floated to obscure...?

**Kewper:** Yes, they did, and they said it was a cover story. The weather balloon was a cover story.

**Howe:** To cover up the fact that extraterrestrials and craft were retrieved.

**Kewper:** Yes. And I asked them why they covered this up. This was 10 years later...

**Howe:** In 1957?

**Kewper:** Right, in 1958 [while visiting Area 51]. I asked him [Colonel Jim], "Why do you continue to cover this up?" Well, he said it was covered originally because the Cold War was just starting and somebody up in the government—I'm sure it was probably President Truman—had requested a tight cover on this because with the Cold War starting and now having aliens flying around, he thought it would be too much for the American public all at once. But it was perpetuated, and even to this day they are still covering it with balloon stories.

**Howe:** Now it is 1998. This is 40 years after you first saw the 16-mm black and white film of the six-fingered humanoid dissection, and there still appears to be a policy of silence and denial about this extraterrestrial interaction. Why do you think the government has not told the United States and the world what they know?

**Kewper:** You would think they would have by now. But I know that at the same time through the Cold War era back in the 1950s—I was involved with it—the CIA in a lot of cases in regards to these unidentified flying objects did contact and work with even the Russians during that time of the Cold War to see what they had, because the Russians had contacted us in regards to UFOs as they had UFO sightings also. They contacted us because they thought it might be some kind of advanced flying craft that we had, and they were calling us to warn us to keep them out of their area because they thought they were our craft. We told them they were not ours.

**Howe:** If Russia and the United States were secretly trying to talk with each other about an extraterrestrial presence, did you ever have any further information over the last 40 years about what our government's understanding of the agenda or intent of these beings is by now?

**Kewper:** I know that we have worked together with Russia on this, especially since the Gorbachev thing and we became more friendly; and that Russia is involved with particle beam weapons, too, from satellite and from ground. We had actually given them the particle beam weapon to be able to shoot down any of the saucer craft.

**Howe:** But why would we try to shoot down craft if we perceived these beings to be benevolent?

**Kewper:** Well, it could be something that happened since that time. I believe it would have happened over the [former] Soviet Union because I know they had a big craft go over that was

almost like a mother ship, and they tried to shoot it down but the thing just shot all the aircraft that they had pursuing it, right out of the air in just a few seconds, with whatever lasers or whatever they [alien craft] had—death rays, something like that.

**Howe:** What is the source of your information on this?

**Kewper:** This is through my friend, through my boss's son. When he talked to me in 1993 he mentioned that they'd had an ugly incident there where the aliens had actually attacked some type of a military base from where they had sent the planes up to attack [the mother ship].

**Howe:** Did you ever learn what type of being was in that craft?

**Kewper:** No, I didn't. Nobody did. It was a flyover-type thing and nothing landed, so no one would know what was actually in there. But I know the big craft contained many small saucer craft; it was almost like an aircraft carrier, like we would have with airplanes on it.

**Howe:** So, in summary, you went from 1957 to 1960 seeing these highly classified reports about extraterrestrial beings, technology and craft. You actually saw 16-mm black and white autopsy/dissection film of the six-fingered humanoid when you were in the CIA. You actually went to Nevada, to Nellis AFB and Area 51, where you personally saw at least seven different craft and the live being that was described as a "grey" with large black eyes and was different from the six-fingered humanoid.

And yet, when you left the Army Signal Corps and CIA work in 1960, there was still no understanding about the relationship between those beings or why they were there.

**Kewper:** Yes, that's right; one-hundred-per-cent right. At that time there was a question mark, a *big* question mark as to why they were here. In some cases—apparently some of the US sightings—they were tremendously friendly.

**Howe:** Were friendly?

**Kewper:** Yes, were friendly. And, of course, there were all the abduction

things that came out later. There weren't any in that original *Blue Book* file that I had seen at that time in *Blue Book*. I know there were quite a few later that said they were abducted.

**Howe:** And did you ever see any references to animal mutilations or unusual deaths?

**Kewper:** Yes. At that time we had it out in Colorado, I think. I saw some of those. Different parts of the animal were taken like samples—the stomachs in some, sex organs in others—and [the animals were] apparently mutilated with a laser weapon of some kind that left very precise cutting edges.

**Howe:** Did you read about any such cases in that 1957 to 1960 time period?

**Kewper:** Yes, especially from Colorado.

**Howe:** Even back then?

**Kewper:** Yes.

**Howe:** And was there speculation on the part of the Central Intelligence Agency or the military about the relationship between these unusual animal deaths and the extraterrestrials?

**Kewper:** Yes. The only thought at that time, if I remember correctly, is that they [extraterrestrials] were taking samples of these various animals on the Earth just to see more or less what their different functions were...

I know that we have worked together with Russia on this... and that Russia is involved with particle beam weapons, too, from satellite and from ground.

Continued on page 88









# REVIEWS

## BOOKS

Reviewed by Ruth Parnell

### **DAMANHUR: The Real Dream** by Jeff Merrifield

Publisher: Thorsons, UK, 1998

ISBN: 0-7225-3496-5 (278pp h/c)

Price: AUD\$39.95; NZD\$59.95;

GBP£16.99; NLGf61,90

Distributors: **Aust/NZ/UK**—HarperCollins Publishers; **Europe**—NEXUS office

A unique community was established in 1977 when a small, spiritually based collective, led by Oberto Airaudi, found a special property in the Piedmont valley of Valchiusella, north of Turin, Italy. The area has a "freak gravitational quality" and is one of only a couple of places where four "synchronic" energy lines converge.

So was Damanhur born, but it was another year before they began their secret mission: to excavate with their bare hands a sacred space inside a mountain and create their *Tempio dell'Uomo*, the Temple of Mankind. Their digging was a metaphor for digging deep into their souls, says author Jeff Merrifield who discovered the community in 1996 and was moved to write this potted history, *Damanhur: The Real Dream*.

The Temple complex consists of several halls—of elements (Earth, Water, Metal), Spheres and Mirrors—linked by corridors and spiral staircases, and exquisitely decorated with stained glass and mosaics designed on esoteric themes for ritualistic purposes. Its existence was broken to the outside world in 1992, bringing the community into conflict with local authorities.

Undeterred, the Damanhurians, 700 of them at last count, continue to flourish.

They live according to a philosophy based on arcane knowledge and esoteric physics which they apply equally and practically to their social, economic and spiritual structures. The fruits of their labours, whether in producing top-quality foodstuffs, visionary art or even time-machines, speak for such grand visions being achievable if sustained with correctly focused energy. Their experiences have relevance for all community-minded individuals.

### **GLIMPSES OF OTHER REALITIES**

#### **Volume II: High Strangeness**

by Linda Moulton Howe

Publisher: Paper Chase Press, USA, 1998

ISBN: 0-473-04505-2 (498pp tpb)

Price: AUD\$55.00; GBP£25.00;

NLGf79,90; USD\$27.95

Available: **Aust/UK/Eur**—NEXUS offices; **USA**—Paper Chase Press, 8175 S. Virginia St #850-D, Reno, NV 89511, ph (702) 826 5947, fax (702) 853 6329

For (and since) volume two of *Glimpses of Other Realities*, subtitled *High Strangeness*, award-winning author/journalist Linda Moulton Howe has accumulated some intriguing testimony from former military insiders who want the truth about UFO/ET phenomena to come out. (See her latest article in this issue.)

This weighty work is really several books in one, covering not only the military evidence but the stories of several "abductees" who claim to have had close interactions with a variety of alien life forms. Howe herself admits that this testimony is hard to verify, but she presents it for what it suggests about how big the 'Big Picture' really is.

It's an incredibly complex blend of scenar-

ios involving time-travelling aliens abducting humans for mind control, physical experiment and soul transfer and even tampering with the very genetic code of humanity at various times in our history. The evidence from some abductees is that such manipulation is frowned upon by higher level extraterrestrials who have access to an Even Bigger Picture—and hopefully have access to a catastrophe override button!

One scenario has the planet's atmosphere set on fire in the not-too-distant future by an Earth-based experiment that may impact on all the other dimensions beyond our awareness. Could this be the HAARP ionospheric experiment gone wrong?

Howe shows the courage of her convictions in presenting these mind-blowing scenarios and attempting to make sense of them in the light of a Greater Whole.

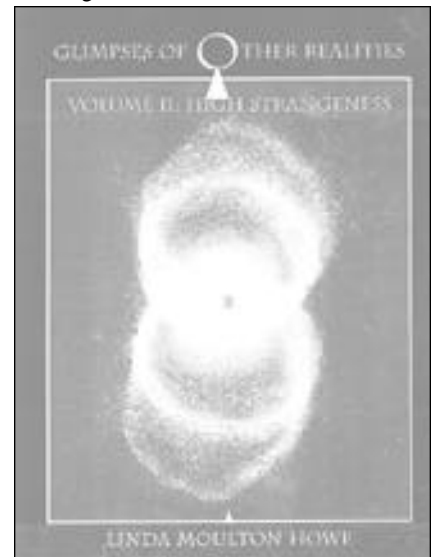

# REVIEWS



## BOOKS

### THE PERILS OF PROGRESS

by John Ashton and Ron Laura

Publisher: UNSW Press, Australia, 1998

ISBN: 0-86840-488-8 (346pp tpb)

Price: AUD\$29.95; NZD\$29.95 + p&h;

USD\$34.95 inc. p&h in USA

Distributors: **Aust**—UNSW Press, Sydney

NSW 2052, ph (02) 9664 0999, e-mail,

sales.press@unsw.edu.au; **NZ**—Green

Phoenix Marketing, ph (06) 355 1298;

**USA**—International Specialized Book

Service, ph 1800 944 6190

The price we've paid for progress has been high, and our economies can no longer be oriented towards growth at any cost. Moreover, that price has exacted an enormous toll on our health and Nature.

The threats to our well-being are everywhere, but as food chemist John Ashton and education professor Ron Laura point out in their latest co-written book, *The Perils of Progress*, we can take precautions in our day-to-day lives to minimise their impact on our health and the environment.

Ashton and Laura consider the dangers posed by electrical, food, water and environmental technology with reference to the latest scientific research. First, they look at the deleterious health effects of electromagnetic fields, mobile phones, microwave ovens, computer VDUs and televisions, and how to counteract them. Next, they present frightening information on just how contaminated our food has become, with processing and additives, toxins like cadmium and aluminium, and irradiation and pesticides exerting unknown effects in combination.

From there, Ashton and Laura warn of the

dangers of poisoning our precious water supplies through chlorination and fluoridation and of polluting our indoor environments with air conditioning and artificial light. In fact, there is strong evidence linking fluorescent lighting with melanoma.

The authors are adamant that ordinary people, organised in grassroots-level campaigns and armed with the facts, can overcome and even eradicate these perils that put our lives and future in such jeopardy.

### ATLANTIS IN AMERICA: Navigators of the Ancient World

by Ivar Zapp and George Erikson

Publisher: Adventures Unlimited, 1998

ISBN: 0-932813-52-6 (398pp trade pb)

Price: AUD\$28.00; NZD\$35.00;

GBP£15.50; NLGf39.90; USD\$17.95

Available: **Aust/NZ/UK/Eur**— NEXUS

offices; **USA**—Adventures Unlimited, PO Box 74, Kempton, IL 60946, ph (815) 253 6390, fax (815) 253 6300

The most overlooked key to understanding the history of ancient civilisations is the role of navigation, say the authors of this engrossing book, *Atlantis in America*. And all navigational roads in the megalithic world led to and from Central America—or Atlantis—according to Professor Ivar Zapp and writer George Erikson.

Prof. Zapp, based at the University of Costa Rica, has spent many years studying the huge stone spheres—some measuring over nine feet in diameter and weighing as much as 20 tons—found in the Diquis Delta region of southwest Costa Rica. While the triangular layout of some of these spheres was mapped in 1949, Zapp has determined that their axes were oriented towards magnetic north and their line projections took in

key regions in the Pacific and Atlantic oceans as well as megalithic temple sites at Stonehenge and the Giza plateau.

These stone sphere arrangements had to have been navigational maps and teaching aids, incorporating knowledge about ocean currents as well as the stars, conclude Zapp and Erikson (who brings chaos theory and archaeoastronomy into the investigation).

Their examination presents a much different picture to the conventional Eurocentric historical world view of the antiquity and evolution of civilisation in the Americas. Moreover, it gives a scathing critique of the Catholic Church's role in rewriting history.

The authors expand their argument with reference to the Beringia myth, evidence of cataclysms over the millennia, new civilisations built on top of old, surviving legends, out-of-context artefacts, and much more.





# REVIEWS

## BOOKS

### LETTER TO EARTH

by Elia Wise

Publisher: Inspired Company, USA, 1998  
ISBN: 0-9625678-1-7 (221pp h/c)  
Price: AUD\$60.00; GBPE26.00 inc. p&h;  
NLGf74,90; USD\$34.00 + \$4.50 p&h;  
CAD\$43.00 inc. p&h  
Available: **Aust**—Cameron Books, ph (02) 4758 7676, fax (02) 4758 9047; **UK/Europe**—NEXUS offices; **USA**—Inspired Company, PO Box 10, Mill Valley, CA 94942, ph (415) 388 6544; (877) 986 3000 (toll-free in US); **Canada**—Words, ph 1800 593 9673

**H**umanity is on the brink of an Age of Inspired Realism in which we will be able to integrate knowledge of the multidimensional nature of things into a coherent whole, inclusive of both science and spirituality. But our transformation to this state depends on the love we bring to bear, writes Elia Wise in her beautifully produced compendium of wisdom, *Letter to Earth*.

The ultimate in adventure travel is the journey into the universe through expanded consciousness—a journey that California-based Wise has been involved with for the last 30 years in her role as a transformational healer/speaker/trainer/writer and "applied metaphysicist". Her personal experience with entry into lofty states of being make her a special kind of tour guide. And her becoming a mother in her late 40s inspired her to pass on, via letters to her daughter and to the world, her acquired wisdom on our place in the cosmos, the nature of good and evil and how we can change our world.

Central to her "theory of everything" is the

universal concept and practice of sympathetic vibrational magnetism (SVM). She explains that energy, no matter how simple or complex, and regardless of its location, has the inherent capacity to interact magnetically with all other energy. Coincidences and synchronicities are demonstrations of SVM: the ability of a unit of energy to attract what it needs for its transformation.

What Wise describes is experiential knowledge and wisdom that is age-old and timeless, and though it has been written about before, she has a unique presentation that is cohesive, instructive and inspirational. The insights abound on every page.

### NORTHUMBERLAND DREAMING: A Past Life Remembered by Mary Rhees Mercker

Publisher: Hampton Roads, USA, 1998  
ISBN: 1-57174-086-4 (422pp tpb)  
Price: AUD\$30.95; NZD\$39.95;  
GBPE11.99; NLGf42,90; USD\$14.95  
Distributors: **Aust**—Gemcraft, ph (03) 9888 0111; **NZ**—Peaceful Living, ph (07) 571 8105; **UK**—Airlift Book Company, ph 0181 8040400; **Europe**—NEXUS office; **USA**—Hampton Roads Publishing Co., ph (804) 296 2772, 1800 766 8009;

**Canada**—Dempsey, ph (604) 708 1081  
**I**f you've ever entertained thoughts and visions of past lives, imagine what it would be like to recall a life experience in detail. This is what apparently happened to Missouri-born Mary Rhees Mercker, who over the years encountered a strange face looking back at her in the mirror. At age 37 she was ready to confront the apparition, and suddenly found herself greeting the male personage as "Sir John". He spoke to her in

mediaeval English about his life and times as a knight in Northumberland, northern England, in the 12th century.

Not content to take this on face value, Rhees Mercker delved into her family genealogy and discovered that she was in fact a descendant of this knight, Sir John Forster, who was born in 1159, was knighted for valour during the 3rd Crusade by Richard the Lionheart in 1190 and died in 1220. Furthermore, she began to realise that she had actually been Sir John in a previous life, and many of the people he loved dearly have been reborn into her present timeline.

Mercker's book, *Northumberland Dreaming*, is the recreation of Sir John's lifetime as pieced together through visionary states as well as study of historical records. In many instances she was tracing some seemingly factual detail, only to be correct-



# REVIEWS



## BOOKS

ed by Sir John whose anecdotes told a slightly different story. In 1996 and 1997 she managed to travel to Northumberland and was able to recognise so many of the locations and sites as seen in her visions.

Fact or fiction, this is a fascinating story told with care for detail. The author's use of mediaeval words gives extra authenticity.

### FLYING SAUCERS OVER LOS ANGELES: The UFO Craze of the '50s by Dewayne B. Johnson

Publisher: Adventures Unlimited Press, USA, 1998

ISBN: 0-932813-54-2 (280pp s/c)

Price: AUD\$27.00; NZD\$34.00;

GBP£15.00; NLGf35.90; USD\$16.00

Available: **Aust/NZ/UK/Eur**—NEXUS offices; **USA**—Adventures Unlimited, ph (815) 253 6390, fax (815) 253 6300

Dewayne Johnson completed his thesis, "Flying Saucers: Fact or Fiction?", in August 1950 as a student in the Graduate Department of Journalism at UCLA, but never published it. Recently Kenn Thomas, of *Steamshovel Press* fame, stumbled upon it and teamed up with AUP's David Hatcher Childress to publish it—the two adding commentary and introduction to what has become *Flying Saucers Over Los Angeles*.

Now close to 50 years old, it remains a valuable social and psychological critique, capturing the feel of the earliest years of the UFO frenzy. Actually, as Thomas points out, LA was swept with UFO fervour as early as 1942 when a US fighter plane had a brush with a globular or triangular shaped craft, but Johnson's coverage primarily takes in reported "flying saucer" events and hoaxes from 1947 (starting with Kenneth Arnold

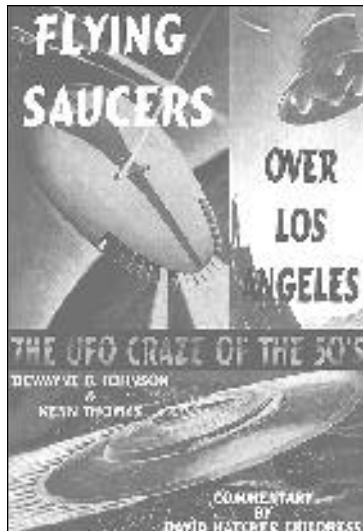

and including Roswell) to 1950.

Apart from analysing newspaper reports and eyewitness accounts with a journalist's eye for detail and a decent dose of wit and irony, Johnson considers the what, why, how, when and whence of the phenomenon, and questions whether the "flying crockery" was of alien origin or the product of Cold War one-upmanship. Was the first wave of sightings recorded in southern California because of the proximity of top-secret bases where saucers were being built?

Interspersed through the text and featured within a special colour section are images from a variety of UFO and sci-fi magazines from the late 1940s to early 1960s. While many of them post-date the text, they add to the atmosphere and are a real treat for UFO nostalgia buffs. This "blast from the past" is certainly a rivetting read.

### REMARKABLE HEALINGS

#### by Shakuntala Modi, MD

Publisher: Hampton Roads, USA, 1997

ISBN: 1-57174-079-1 (632pp tpb)

Price: AUD\$31.95; NZD\$49.95;

GBP£15.99; NLGf45.90; USD\$18.95

Distributors: **Aust**—Gemcraft, ph (03) 9888 0111; **NZ**—Peaceful Living, ph (07) 571 8105; **UK**—Airlift Book Company, ph 0181 804 0400; **Europe**—NEXUS office; **USA**—Hampton Roads, ph (804) 296 2772, 1800 766 8009, fax (804) 296 5096; **Can**—Dempsey, ph (604) 708 1081

A decade ago, psychiatrist Dr Shakuntala Modi was not quite prepared for one of her patients to go into a spontaneous past-life regression during a regular hypnosis session, and certainly not for another patient several months later who declared he was possessed by a demon.

Working through these experiences with her patients, she soon discovered that past-life traumas and possessions by spirits (whether Earthbound or demonic) are so real that they leave physical, emotional and mental scars. The experiences forced upon her a re-evaluation of her practices and the fundamentals upon which her profession is based—so much so that she believes psychiatry will eventually come out of denial about the reality of these phenomena.

To her relief, Dr Modi found that these traumas can be eliminated—and, in some cases, exorcised. In most instances it would take no more than a couple of hypnosis therapy sessions for the patient to connect with and accept his past-life trauma, possession or even "loss of soul parts", and then be free of his ailments. In some cases, a great number of sessions would be required so as to connect with at least a dozen trauma incidents before the patient's chronic physical



# REVIEWS

## BOOKS

condition could be alleviated.

Dr Modi's discoveries and her patients' amazing case histories make for compelling reading in her book, *Remarkable Healings*. While she doesn't make serious forays into the realms of alien abduction or mind control, Dr Modi does make valuable inroads in expanding the boundaries of normality.

### FACES OF THE VISITORS: An Illustrated Reference to Alien Contact by Kevin Randle and Russ Estes

Publisher: Fireside/Simon & Schuster, UK, USA, 1997

ISBN: 0-684-83973-3 (309pp tpb)

Price: AUD\$19.95; NZD\$24.95;

GBP£8.99; NLGf28.90; USD\$12.00

Distributors: **Aust/UK/USA/Canada—**

Simon & Schuster; **NZ—**MacMillan, ph

(09) 415 6672; **Europe—**NEXUS office

In case you've only just progressed from little green to little grey men, you're in for a surprise. Over the last 50 years, witnesses around the world have reported over 100 different types of alien creatures making their presence known, and a cross-section of them is featured in *Faces of the Visitors*.

For this book, UFO researcher/author Kevin Randle and artist/documentary-maker Russ Estes describe/portray a wildly diverse range of sightings: beings ranging from three inches to 10 feet tall; creatures from the slug-like to the robotic and the reptoid; humanoids from the Nordic to the cat-eyed; and a variety of big-eyed/eared/nosed entities possessing varying degrees of intelligence and compassion towards humanity.

The authors give a "reliability rating" with each case summary. On a scale of 1-10,

they give some cases a high rating based on the number of witnesses involved, and other cases a low score due to lack of corroborative evidence. Their case studies are divided into three categories: reports from witnesses who saw the alien(s) at close range; from contactees who claim interaction with beings supposedly here to help us; and from abductees who mostly claim they've been experimented upon against their will.

This "illustrated reference to alien contact", replete with vast UFO-related bibliography, also chronicles two important "visitation" waves: a 1954 Europe/South America flurry, and a 1973 North American flap.

The authors admit there is surprisingly scant photographic evidence from all these encounters, but they include a couple of now-familiar and quite weird examples here.

### TECHNOLOGY'S CURSE: Diet for the Atomic Age

by Sara Shannon

Publisher: Earthpulse Press, USA, 1998

(first published 1987, revised 1993)

ISBN: tba (373pp h/c; soon in s/c)

Price: AUD\$60.00; GBP£n/a; NLGf n/a;

USD\$27.95

Available: **Aust—**Cameron Books, ph (02)

4758 7676, fax (02) 4758 9047; **UK/**

**Europe—**NEXUS offices (see page 2);

**USA—**Earthpulse Press, PO Box 201393,

Anchorage, AK 99520, voicemail (907)

249 9111, fax (907) 696 1277

The evidence that radioactive substances are the most powerful toxins in our food led Sara Shannon, a now-retired New York City-based nutritionist, to write *Diet for the Atomic Age*. That was over 10 years ago, and the book has now been republished as *Technology's Curse*. Its message is just as pressing today as the long-term effects of past nuclear disasters become increasingly evident and the possibility of future accidents more likely. And with electromagnetic pollution now so all-pervasive in our lives, her advice is ever more critical.

In the late 1970s Shannon started exploring the suggestion that certain foods had radioprotective qualities and could help detoxify or counteract radiation's hazardous effects. She found that garlic, whole grains, nuts and seeds, vitamin/mineral supplements, tempeh, leafy green and yellow vegetables have beneficial properties, with sea vegetables being especially rich in detoxifying minerals. She also learnt why meat, fish, milk and anything that's refined and processed are best avoided.

Sadly, we have to be very choosy even about our radioprotective food sources: that our leafy greens weren't grown downwind of a nuclear or chemical plant with fertiliser

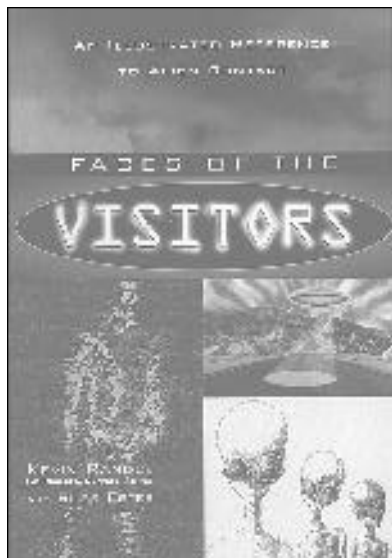

# REVIEWS



## BOOKS

contaminated with radioactive waste or toxic sewage sludge. However, rather than dwell on gloom and doom, we *can* take positive steps for our personal and planetary health. Shannon lists a range of contacts and resources we can follow up—but we can always distract ourselves in the kitchen experimenting with her tempting recipes!

### THOTH: Architect of the Universe

by R. Ellis

Publisher: Edfu Books, UK, 1997

ISBN: 0-9531913-03 (h/c)

Price: AUD\$poa; GBP£14.99 + £2 p&h;

NLGf53.90; USD\$25.95 +p&h

Distributors: **Aust**—Specialist

Publications, ph (02) 9736 2191; **UK**—

Edfu Books, PO Box 3223, Dorset BH31

6FJ, ph/fax 01202 828886, e-mail,

kena.edfu@virgin.net; **Europe**—NEXUS

office; **USA**—Adventures Unlimited, ph

(815) 253 6390

This treatise is less about the Egyptian god Thoth in his various guises than the legacy he has left around the planet. A number of mythologies have it that Thoth endowed upon evolving humanity the knowledge of architecture, astronomy, mathematics, measurement, physics as well as reading and writing. So why shouldn't he leave messages encoded in monuments for future generations to decipher?

Author R. Ellis is one of many researchers devoted to the task, and the findings he presents in *Thoth: Architect of the Universe* are illuminating, though often inconclusive. Ellis notes the mathematical commonalities, such as the *pi* ratio, that are evident in the pyramids at Giza and Dahshur in Egypt, the



major Neolithic sites in Britain such as Stonehenge, Avebury and Silbury Hill (a buried step pyramid?), and the pyramids at Teotihuacan in Mexico—and sees the hand of Thoth in every monument and site. The peak of Thoth's activity, according to Ellis's calculations, was around 13,700 years ago, but this date is based on movements in the Earth's axis that are assumed to be constant.

So why should Thoth spark off new civilisations and then depart without leaving any records in a safe place? And where could that place be? Ellis proposes that the layout of the Great Pyramid (upside down) and Stonehenge can be viewed as maps of the globe, both of them pointing to a place: the Sandwich Islands, arguably one of the last vestiges of Atlantis! Could one of Thoth's repositories be located there? Who knows!

### THE HIDDEN MAYA

by Martin Brennan

Publisher: Bear & Company, USA, 1998

ISBN: 1-879181-24-X (281pp tpb)

Price: AUD\$39.95; NZD\$52.95;

GBP£16.99; NLGf44.00; USD\$20.00

Distributors: **Aust**—Gemcraft, ph (03)

9888 0111; **NZ**—Peaceful Living, ph (07)

571 8105; **UK**—Airlift Book Company, ph

0181 8040400; **Eur**—NEXUS office, ph

+31 (0)321 380558; **USA**—Bear & Co.

Publishing, ph (505) 983 5968, 1800-WE-

BEARS, fax (505) 989 8386

The use of handsigns in art and sculpture is prevalent in many spiritual traditions, but the Maya were especially prolific in their use of handsigns or manographs in the glyphs decorating their artefacts. In *The Hidden Maya*, author Martin Brennan reveals that these manographs are the keys to the very core of Maya thought.

Brennan explains how hand gestures played an intrinsic role in the development of writing, and how, with a variety of dialects in the Maya lands of Central America, a commonly understood sign language developed into a complex artistic language with both mundane and esoteric meanings. Indeed, contrary to scholarly opinion, it would appear that the North American Plains Indians borrowed their sophisticated sign language system from the south—a realisation that drew Brennan to the Maya in the first place.

When he compared their handsigns with the glyphs from the Maya codices and artefacts, Brennan found that the hand gestures are central to understanding the glyph's meaning and, moreover, that the manographs retain the inherent logic of the handsign system. As he decoded, the hands literally opened a new door to a deeper understanding of Maya cosmology, their astrono-





# REVIEWS

my and number science and the purpose of their rituals. Often his translations differ from those accepted by scholars—so expect some lively debate.

This detailed, well-illustrated journey into the hidden realms of the Maya is also testament to the intrinsic role of hand/finger manipulation in the evolution of the human brain and the development of civilisation.

## BREAKING THE SOUND BARRIER OF HUMAN ENERGY PRODUCTION

by John O'Neill

Publisher: John O'Neill, Aust, 1997 (3ed)

ISBN: 0-646-31948-5 (s/c)

Price: AUD\$25.00 inc. p&h; overseas orders AUD\$30.00 inc. p&h

Available: **Australia**—John O'Neill, 56 Julie Way, Mudgeeraba Qld 4213, ph/fax +61 (0)7 5530 5982 (see ad on page 95)

The Q10 enzyme (ubidecarenone) is the greatest nutritional discovery in molecular science to date—in the opinion of John O'Neill, an extremely healthy, fit and athletic 59-year-old who's been researching physiology and sports medicine for decades. All you wanted to know about Q10 and more is covered in his book, *Breaking the Sound Barrier of Human Energy Production*.

Anyone interested in maximising their energy, or who does intensive training whatever the sport, can learn a great deal from it.

Q10 is the critical enzyme needed by the cell mitochondria to produce energy. But for the mitochondria to operate efficiently, toxic by-products like lactate, ammonia and carbon dioxide must be limited. If not, the electron transport system (ETS) suffers and can no longer split hydrogen atoms and convert their protons and electrons to water with the help of oxygen (and Q10), and thus the entire body suffers. Considering how we

plague our systems with toxins, we are only bringing on the ageing process and encouraging disease. Our livers can barely keep up with our cellular demands for Q10.

Fortunately, Q10 supplements are non-toxic and reportedly have no side effects—except for improved health, energy and longevity! But, as with all supplements on the market, some are better than others, and consumers need to be well-informed to sort out the wheat from the chaff. This book is one of the few covering Q10 in the context of human cell energy efficiency.

## PRE-TASMAN EXPLORERS

by Ross Wiseman

Publisher: Discovery Press, NZ, 1998

ISBN: 0-473-04505-2 (406pp s/c)

Price: NZD\$49.95 inc. p&h in NZ; overseas p&h add NZD\$6.00

Distributors: **New Zealand**—Chris Beckett Ltd, ph (09) 415 8844; overseas orders through Discovery Press, ph +64 9 836 0772, fax +64 9 837 6364

Historians tend to act as guardians of the prevailing cultural paradigm, argues researcher Ross Wiseman, and in New Zealand (as in Australia, for that matter) it is reinforced by promotion of Capt. James Cook's "discovery" in 1768 over that of the Dutch Abel Tasman in 1642. But in *Pre-Tasman Explorers*, Wiseman reminds us that NZ has been visited, mapped and even settled several times in the last 2,600 years.

A number of artefacts have been found that are inconsistent with the prevailing paradigm and whose validity has been denied or ignored by academia. Wiseman analyses the historical background of each item as far as it can be traced, and draws reasonable conclusions that should encourage heated discussion. He dates an iron helmet dredged from Wellington Harbour in 1888 to a visit by Spanish explorer Capt. Juan Fernandez in 1576. But the Portuguese had already mapped the east coast of both islands in 1522, as depicted in the 1536 Dauphin map drawn up by French cartographers.

Other visitors or settlers included the Tamils who left behind a ship's bell in the 1170s, the Maori who arrived c. 850–870, Arab sailors who lost a bird carved of green serpentine (not found in NZ) in the 790s, Ptolemaic Greeks c. 180 BC, Mauryan sailors who brought the rat from India around 240 BC, and Phoenician settlers c. 666 BC. The Phoenicians left clues to their presence in stone, but their likely settlement around Lake Taupo in the north island was probably destroyed by volcanic eruption in AD 186. Much evidence still lies buried, so Wiseman puts out an impassioned plea for archaeologists to continue the research.

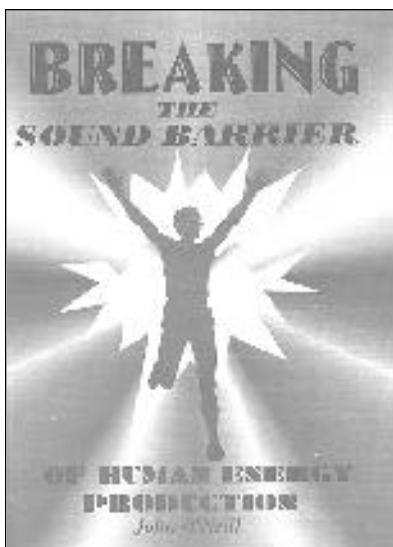

# REVIEWS



## VIDEOS

Reviewed by Duncan Roads

### HOLES IN HEAVEN? HAARP and Advances in Tesla Technology

Producer: Paula Randol-Smith Productions, 1998, PO Box 91655, Pasadena CA 91109-1655, USA; ph/fax 626 395 9777 (PAL & NTSC, 51mins)  
Price: AUD\$45.00; NZD\$59.00; STG£22.00; USD\$29.95

Available: **Australia**—NEXUS Magazine, PO Box 30, Mapleton Qld 4560, ph (07) 5442 9280; **NZ/UK/Eur**—NEXUS offices; **USA**—Adventures Unlimited, ph (815) 253 6390, fax (815) 253 6300

This is a really good video! It is professionally produced, excellently researched, is up to date and has all the major players involved with the HAARP ionospheric project featured on the film—in most cases making rather scary comments.

Readers who are still wondering what on Earth HAARP is should read the article in NEXUS 2/22 (Oct-Nov '94) (the very first article to appear anywhere on HAARP!) and the update in NEXUS 3/01.

The documentary uncomfortably reveals that the project directors themselves still are not certain what outcome or side-effects will eventuate from this vast experiment with the Earth's ionospheric layers.

Considering these experiments will affect all life in the northern hemisphere, and most likely the southern hemisphere as well, it is time more countries became aware of what the Americans are attempting to do.

## PRODUCT

Reviewed by Duncan Roads

### AIR SUPPLY™ Personal Air Purifier

Designed and manufactured by Wein Products, Inc., Los Angeles, CA, USA  
Distributed in Australia by Inner Glow Health Products Pty Ltd, PO Box 199, Warrandyte Vic 3113; ph (03) 9844 4471, fax (03) 9844 4884

An air purifier you can wear? It even comes with a plug that can be inserted into your car's cigarette lighter. The pamphlet accompanying the gadget suggests the air purifier can be worn in a shirt pocket or around the neck. Indeed, it is as small as a pocket beeper.

The claims and accompanying test results (from UCLA) indicate that it draws in and destroys germs, odours, dust, mould, spores and even toxic chemicals—while emitting pure, clean air. Weighing in at only 4 ounces, it operates on a 9-volt battery and makes only the faintest hum.

## VIDEOS

... received but not reviewed ...

### REMEMBERING THE END OF THE WORLD (from the Mythscape Series)

Producer: Kronia Comms Inc., USA, 1996 (PAL & NTSC, 90mins)  
Available: Kronia Communications Inc.; ph 1800 230 9347 (USA only); e-mail, kronia@kronia.com; website, <http://www.kronia.com/>—kronia

Actually, I did watch this one! It's about Immanuel Velikovsky. In the 1950s Velikovsky became well-known for his theories that the Earth's ancient past was dominated by catastrophe and cosmic upheaval. His research led to the conclusion that many early civilisations were nearly destroyed by the close approach of a great, legendary comet—an intruder Velikovsky identified as the planet Venus.

### THE MONEY MASTERS: How International Bankers Gained Control of America

Producer: Patrick S. J. Carmack for Royalty Productions (2-tape set, PAL & NTSC, duration n/a)  
Available: Money Masters Video, Box 114, Piedmont, OK 73078, USA; ph 1888-THEPLOT (ext. 60) (toll-free in US only)

At the time I write this, I have only watched about two-thirds of tape A, and I must say I'm looking forward to watching tape B. What I have seen so far reveals what I would agree is a "hidden history" of both Europe and America, especially if one is interested in the "money flow".

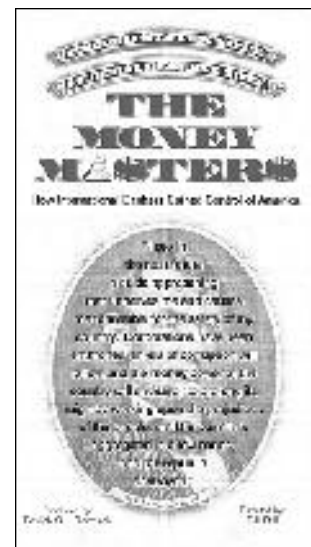



# REVIEWS

## AUDIO

Reviewed by Richard Giles

### BOTHY CULTURE

by Martyn Bennett

Producer: Martyn Bennett for Rykodisc, UK, 1997 (59mins)

Distributors: **Australia**—Festival ph (02) 9660 4022; **UK**—Rykodisc, ph 0181 746 1234; **USA**—Rykodisc, ph (508) 744 7678

Combine Scottish bagpipes, Celtic fiddle and Gaelic sound with cutting-edge electronic rave/dance music and you've got Martyn Bennett's high-energy sound. It's fascinating today to hear the range of new music combining the traditional with wild grooves. Bennett, classically trained at the Royal Scottish Academy of Music, is one of a new generation of musicians taking the music of their roots and fusing it with rock to make new inroads into late-20th-century music populism. Be prepared for some crazy and invigorating sounds on this *Bothy Culture* album.

### DANCE IN THE FIRE

by Paul Cheneour and Dilly Meah

Producer: Roland Clark and Paul Cheneour for RGM, UK, 1998 (61mins)  
Price: STG£12.50 + £1.50 p&h (£2 o/s)  
Distributor: **UK**—RGM Ltd, West Sussex, ph 0181 668 4444

Two musicians, one from a Western background, the other from an Eastern, combine to produce music in the moment. Paul Cheneour plays a range of flutes (and has previously released a number of his own flute albums), and Dilly Meah plays tabla. Between them they create an extraordinary woven tapestry of sound and feeling; the combination is just exquisite. On this new album, *Dance in the Fire*, their co-creative energy produces some magical and inspiring moments of sound. An excellent collaboration between two top musicians.

### SURA

by Chloë Goodchild

Producer: Chloë Goodchild for Raven Recording, NJ, USA, 1998 (56mins)  
Distributors: **Aust**—New Age Media, ph (08) 9430 7777; **USA**—Raven Recording, ph 1800-76-RAVEN or (973) 642 1979; **Germany**—ph +49 8105 384858

Chloë Goodchild's album *Sura* reflects her dedication to the true spiritual traditions of the world—with music from the Sanskrit mantram "Gayatri", the "Ave Generosa" of the mediaeval Rhineland mystic Hildegard, an ecstatic love poem by the 13th-century Kashmiri mystic Lalleshwari, an ancient Jewish chant, an Eastern

European improvisation, and more. Chloë, who leads vocal training workshops, is the author of several books and has released 18 albums. Her "musical landscapes" are inspired by African magical, Asian mythical and European harmonic music, and *Sura* is an interface of all those styles.

### BENEDICTION MOON

by Pia

Producer: P. J. Booker for New World Music, Suffolk, UK, 1998 (58mins)

Distributors: **Australia**—New World Productions, ph (07) 3367 0788; **UK**—New World Music, ph 0198 678 1682

Disturbingly beautiful, angelic music is the way to describe *Benediction Moon*. Made with the support of friends and mentors, this is Pia's first solo album. The lush orchestral sound arrangements and Pia's gorgeously powerful voice sweep the listener into the spiritual realms. Her aim is to use her voice in "service to God and the entire creation". With background training from renowned Bengali musician Haridas Ganguli, Pia is fittingly at home in this musical kingdom. Excellent album.

### COSMIC TREE

by Yulara

Producer: Robert Matt for Higher Octave Music, USA, 1998 (58mins)

Distributors: **Australia**—MRA Entertainment, ph (07) 3849 6020; **USA**—Higher Octave, ph 1800 562 8283

If you feel tuned to soft, ambient jazz and the mix of instruments from half a dozen cultures, *Cosmic Tree* will entrance you. Annie Hilsberg and Robert Matt—Yulara—play flute, sax, keyboards and percussion backed by several musician friends on tabla and guitar, and recorded chants from Tibet, Borneo and India. Selected numbers are mixed with the ambient sounds of nature from places like Peru and India. A very mellow world/jazz/fusion album, capturing the spirit of the planet working together.

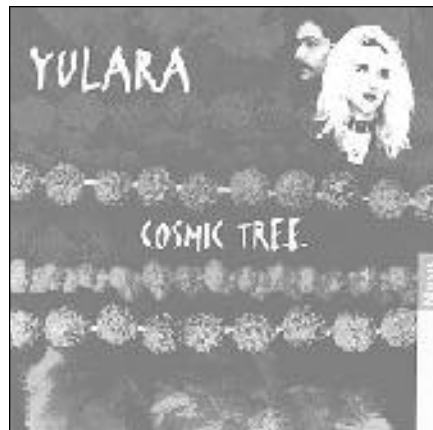



Continued from page 24

during the hearing, two more air disasters occur; in one of them, over a hundred people are killed. They were due to problems that I was identifying, and the crashes occurred in my area of responsibility. They were due to the same problems that I was bringing out and that FAA management was fraudulently denying existed. It makes for a helluva story."

And what are the reasons for the corruption? Were airline officials just paying off FAA top officials? What is the motivation for these continuing crimes, cover-ups and air safety violations?

"There are several reasons," Stich explained. "One, the revolving door syndrome which is in many government agencies. Government employees, usually management, are placating industry, doing anything they can to get brownie points so that when they leave government service they get high-paying jobs in industry.

"Then, of course, there's pressure on the FAA from members in Congress who are getting healthy contributions from industry. And when that pressure is put on the top of the FAA, it goes all the way down the line.

And for all of these FAA people who cooperate, there are different ways they can be rewarded. So the fellow who's trying to do his job, and insists upon doing it, suffers retaliation. But for all those who play the game, there are various rewards that they get.

"Then you have the incompetents in the FAA. You get someone at management level. He doesn't want to fight with industry. First of all, he's not competent to take them on. The point of an inspector is to bring out unlawful or unsafe practices. The management people don't want to hear this. Reports are made and destroyed. If an inspector persists, there are many ways that he can be retaliated against—if he doesn't get the message.

"The FAA came into being in 1958 from the Civil Aeronautic Association after a United Airlines aircraft rammed into a TWA airliner over the Grand Canyon. That received so much publicity that Congress legislated the Federal Aviation Act of 1958. I went with the FAA shortly thereafter. The function of the FAA is to promote safety and to issue rules and regulations and have inspectors to see that they're carried out. But there are many

problems in the system."

No kidding. The biggest problem seems to be to figure out who will watch the watchers. How can government agencies remain accountable to the citizens rather than so-called special interest and industry groups?

Another obvious parallel in the United States is the relationship between the Food and Drug Administration (FDA) which is supposed to be a public guardian of health, and the pharmaceutical industry which is involved in the same kind of bribery, corrupt practices and 'revolving door' policies of agency employees and industry executives. The Securities Exchange Commission (SEC) and the so-called securities industry are another case in point.

So what can be done to break the chains of corruption?

"We could clean out the Justice Department for one thing and provide some type of workable solution where inspectors or government agents could get protection if they are being retaliated against," Stich commented.

Isn't that what the Whistleblower Act is all about?

"It doesn't work for those who are report-

Continued from page 85

ing high-level government corruption," Stich explained. "That's okay if you report misconduct of industry, and that industry is not being protected by high-level government management. Let me quickly mention that over a period of years, as I'm getting more publicity, I'm getting more and more government agents coming to me all the time. I can think of a dozen of these people who attempted to report serious, high-level government corruption and suffered retaliation."

### DARK NIGHT OF THE SOUL

*Defrauding America* is essential reading for everyone who cares about freedom. It's exhilarating—and disheartening—because it contains hard evidence of state-sponsored terrorism by the US Government against its own citizens.

When Rodney Stich found himself in prison because of his whistleblower activities, his own personal nightmare was in full swing.

"Many times I thought to myself: 'My God, how can this be happening to me? This can't be!'" he writes. "I couldn't

believe that what started out with discovering deadly air safety and criminal violations at United Airlines could have such devastating consequences for me...

"How could I be in prison for refusing to commit the crime of cover-up? Where were the media, the so-called protectors against government tyranny?..."

"It was all so incomprehensible. I had been financially well off. I had a good life. I had a reputation throughout the United States as an air safety activist, and suddenly I found myself in prison and stripped of the assets I'd worked for the past 20 years to acquire, all because I felt a sense of responsibility..."

"Sometimes I just wanted to die. The strain of all this was getting to me. Flung into prison, things looked bleak. Everything was accumulating: the six years of judicial persecution; the loss of my home, my business, my assets; the humiliation, the character assassination, the loss of privacy and the hopelessness. There is only so much a person can stand. It caused me to think more than once of ending it all. I had been through World War II as a navy pilot in the Pacific; I had flown for almost 50 years, experiencing all kinds of aircraft

emergencies; I had been caught in Iranian revolutions. All these stressful conditions put together did not equal the fear I now experienced..."

"I looked at the plastic bags used for laundry and other purposes and thought how peaceful things could suddenly become if one were slipped over one's head and the misery ended. The primary thing preventing me from doing such a thing was the hope that I could expose the corruption in government and somehow motivate the American people to exercise their responsibilities under our form of government. What a dreamer I must have been."

Not only a dreamer, Rodney Stich is a courageous individual who has put his sense of justice above everything else.

Continued in the next issue of NEXUS...

### About the Author

Uri Dowbenko is a writer and syndicated columnist. His "alt.media" column is an entertaining and informative critique of current movies, books and pop culture with a social and political commentary. Samples of the column can be obtained from: alt.media, PO Box 43, Pray, Montana, 59065, USA; website, <u.dowbenko@http://www.mailcity.com>.

## Shaken Baby Syndrome: The Vaccination Link

Continued from page 38

responsibility for vaccine injuries and unlawfully tries to take away your constitutional, democratic and legal right to have control over your own and your children's health without being hassled and victimised?

### Endnotes

1. Caffey, J. (1972), "On the theory and practice of shaking infants", *Am. J. Dis. Child* 124, August 1972.
2. Caffey, J. (1974), "The whiplash shaken infant syndrome: manual shaking by the extremities with whiplash-induced intracranial and intraocular bleeding, linked with residual permanent brain damage and mental retardation", *Pediatrics* 54(4):396-403.
3. Reece, R. M. (1993), "Fatal child abuse and sudden infant death syndrome", *Pediatrics* 91:423-429.
4. Duhaime, A. C., Alario, A. J., Lewander, W. J. et al. (1992), "Head injury in very young children mechanisms, injury types and ophthalmologic findings in 100 hospitalized patients younger than two years of age", *Pediatrics* 90(2):179-185.
5. Levine, S. and Sowinski, R. (1973), "Hyperacute allergic encephalomyelitis", *Am. J. Pathol.* 73:247-260.
6. Iwasa, A., Ishida, S., Akama, K. (1985), "Swelling of the brain caused by pertussis vaccine: its quantitative determination and the responsible factors in the vaccine", *Japan J. Med. Sci. Biol.* 38:53-65.
7. Munoz, J. J., Aral, H., Bergman, R. K. and Sadowski, P. (1981), "Biological activities of crystalline pertussigen from *Bordetella pertussis*", *Infection and Immunity*, September 1981, pp. 820-826.
8. Wilkins, J. (1988), "What is 'significant' and DTP reactions" (letter), *Pediatrics* 81(6):912-913.
9. Devin, F., Roques, G., Disdier, P., Rodor, F. and Weiller, P. J. (1996), "Occlusion of central retinal vein after hepatitis B vaccination", *Lancet* 347:1626, 8 June 1996.
10. Goetting, M. G. and Sowa, B. (1990), "Retinal haemorrhage after cardiopulmonary resuscitation in children: an etiologic evaluation", *Pediatrics* 85(4):585-588.
11. Jacob, J. and Mannino, F. (1979), "Increased intracranial pressure after diphtheria, tetanus and pertussis immunization", *Am. J. Dis. Child* 133:217-218.
12. Woerner, S. J., Abildgaard, C. F. and French, B. N. (1981), "Intracranial haemorrhage in children with idiopathic thrombocytopenic purpura", *Pediatrics* 67(4):453-460.
13. Cody, C. L., Baraff, L. J., Cherry, J. D., Marcy, S. C. and Manclark (1981), "Nature and rates of adverse reactions associated with DTP and DT immunizations in infants and children", *Pediatrics* 68(5):650-660.
14. Meadow, R. (1995), "What is and what is not 'Munchausen syndrome per proxy'?", *Arch. Dis. Child* 72:534-538.
15. Yawata, Makoto (1994), "Japan's troubles with measles-mumps-rubella vaccine", *Lancet* 343:105-106, 8 January 1994.
16. Higson, N. (1995), "Evaluating the measles immunisation campaign", *British Medical Journal* 311:62.
17. Wakefield, A. J., Murch, S. H., Anthony, A., Linnell, J. et al. (1998), "Ileal-lymphoid-nodular hyperplasia, non-specific colitis and pervasive developmental disorder in children", *Lancet* 351:637-641, 28 February 1998.
18. Ronne, T. (1985), "Measles virus infection without rash in childhood is related to disease in adult life", *Lancet*, 5 January 1985, pp. 1-5.
19. West, R. O. (1966), "Epidemiologic studies of malignancies of the ovaries", *Cancer*, July 1966, pp. 1001-07.
20. Craighead, J. E. (1975), "Report of a workshop: disease accentuation after immunisation with inactivated microbial vaccines", *J. Infect. Dis.* 1312(6):749-754.

### About the Author

Viera Scheibner, PhD, is a retired principal research scientist with a doctorate in natural sciences. During her distinguished career she published three books and some 90 scientific papers in refereed scientific journals.

Since the mid-1980s when she helped develop the Cotwatch breathing monitor for babies at risk of cot death (sudden infant death syndrome, or SIDS), she has done extensive research into vaccines and vaccinations and in 1993 published her book, *Vaccination: The Medical Assault on the Immune System*.

Dr Scheibner is often asked by lawyers to provide expert reports for vaccine-damage court cases, and she regularly conducts lectures. Her previous articles for NEXUS covered the SIDS/vaccines link (2/05) and the brain-eating bugs/vaccines connection (3/03).

Continued from page 72

**Howe:** Do you think that this story should be told in its entirety today?

**Kewper:** Yes, I think it should. I think it would be helpful in explaining it, first of all. We still have a lot of sightings to this day and age.

**Howe:** And this is why you're talking to me?

**Kewper:** Yes.

### EPILOGUE

After this audiotaped interview was broadcast on the North American syndicated radio programs *Dreamland* and *Coast To Coast AM Hosted by Art Bell*, I learned from Kewper that he'd contacted a phone company executive in his city to inquire about the source of the anonymous call to him on May 25. He was told that the source was the Wackenhut Corporation—a security operation that works for the National Reconnaissance Office and other sensitive military and intelligence agencies in the United States.

More than 50 years after the 1947 Roswell incident, a major question is: What do the United States, England,

Australia other American ally government insiders—and, according to Kewper, even Russia—know which sustains the Orwellian policy of silence and denial in which lies are ordered to become official truth?...as written so strongly in SOM1-01, the Majestic-12 Group Special Operations Manual of April 1954:

Any encounter with entities known to be of extraterrestrial origin is to be considered to be a matter of national security and therefore classified TOP SECRET. Under no circumstance is the general public or the public press to learn of the existence of these entities. The official government policy is that such creatures do not exist, and that no agency of the federal government is now engaged in any study of extraterrestrials or their artifacts. Any deviation from this stated policy is absolutely forbidden.

What will it take to change this policy instigated by US President Harry S. Truman's Executive Order in 1947? What military-industrial-complex interests are so

vested in perpetuating the suppression, and why? It seems a right of the entire global human family to know that we are not alone in this universe, and that extraterrestrial biological entities and other-dimensional entities have been interacting with this planet for aeons, affecting our biological, social and religious evolutions. But why?

**Note:** If any readers have more information, please fax Linda Moulton Howe in the USA on (215) 491 9842, or write to her as per details on the first page of this article.

### About the Author:

Linda Moulton Howe is a graduate of Stanford University, USA, and has a Masters Degree in Communication. She is a science and environmental reporter for radio and television. Her film documentaries, *A Strange Harvest* and *Strange Harvests 1993*, explored the worldwide animal mutilations phenomenon. Her books include *An Alien Harvest*, *Glimpses of Other Realities—Volume I: Facts & Eyewitnesses*, and, most recently, *Glimpses of Other Realities—Volume II: High Strangeness* (Paper Chase Press, USA, phone (702) 826 5947; see review this issue).

Ms Howe's investigations have taken in such diverse subjects as crop circles, the *chupacabras* mystery, humanity's hidden history, and the evidence for UFOs and ETs, including research into the alleged Roswell UFO crash fragments and government knowledge and cover-up of non-human intelligences interacting with our planet.